

Teo Lehtimäki Oy

2009-2010

04-9128R
38 x 305 cm
44 mm kam

Norge



04-9128R
Delning
2,86"



Uppdaterat 18.10.2009



Teo Lehtimäki Oy er ett finsk familjefirma, som ble grunnlagt 1991. Vi selger reservedeler til sneskootere, og vi eksporterer våre produkter til firmaer i Scandinavia, Alpeområde i Europa, Estland og Russland.

Vi selger kvalitetsprodukter som er produsert i Finland, og vi formidler reservedeler fra kjente produsenter, som Camoplast, CVTech-IBC Canada, PPD Industries og Garland.

Vi designer og utvikler egne produkter, eks. den populære brede skiplast "Vuotsalainen" og forlengningsatser som passer til alle skootermerker....

Firmaets virksomhet bygger på fleksibilitet, og raske leveranser.

Vi har lang erfaring, og har reservedeler inne på lager for modeller langt tilbake i tiden. Helt til da de første sneskootere ble levert. På disse sider kan du finne både tekniske råd, monteringsanvisninger, og anvendelses-område for ulike reservedeler.

Disse sider oppdateres kontinuerlig, så det lønner seg å besøke sidene nu å da.

Katalog 2009-2010

Viktig ved bestilling: Oppgi alltid tydelig referansenommer.
(originalnummer er angitt til veiledning)

Teo Lehtimäki Oy

Kaarronnevantie 54 61800 Kauhajoki Finland

Vesa Peltonen

mob. +358-40-5769111 Vesa Peltonen

fax +358-6-2311170

info@teolehtimaki.fi

vat. FI08350750

Teo Lehtimäki Oy

Vuopajantie 34 96400 Rovaniemi Finland

Artturi Lehtimäki

mob. +358-400-162110 Artturi Lehtimäki

fax +358-16-366004

Personliga e-mail adresser

vesa@teolehtimaki.fi

Vesa Peltonen

artturi@teolehtimaki.fi

Artturi Lehtimäki

Ekonomi

Eeva Lehtimäki

eeva@teolehtimaki.fi

www.teolehtimaki.fi

01-100 Laddare 12 V



Vuotsolainen för Pilotskida Nyhet 31-04



31-04

Vuotsolainen för Pilot / RMK skida
design skyddat, bredd 195 mm, 8 mm

Polaris plastskida m.fl 2007

31-04



MM148
MM202

31-04

Yamaha, bred skida m.fl 2007

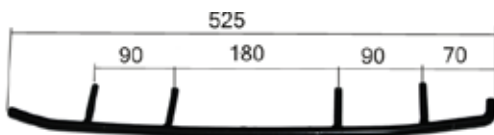

MM139



31-04

Yamaha, smal skida m.fl 2007

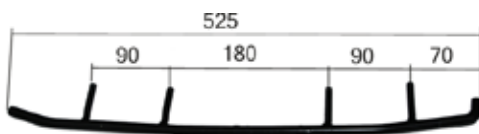

MM139



31-04

CTRL skida Lynx



MM186
MM243



Malli: MXZ 583

Vuosi: 1996 Skidoo

Moottori Rotax 583 96- Teho kW

09-772	mäntä, std
09-772-01	mäntä, 0,25 ylikoko
09-772-02	mäntä, 0,50 ylikoko
09-772-03	mäntä, 0,75 ylikoko
09-772-04	mäntä, 1,00 ylikoko
35-505	männäntapin laakeri
710-214	tiivistesarja, prof
09-167	kampiakselin tiiviste
09-165	kampiakselin tiiviste
09-16002	välitiiviste kampiakseli
35-6206NR	kampiakselin laakeri
35-6207NR	kampiakselin laakeri
35-6305	kampiakselin laakeri
01-158	käynnistimen jousi
01-154	käynn. korjaussarja



Omistaja: **Teo Lehtimäki**, myyty

Kuvassa **Tommi ja Lotta**

38

307 / 22

**04-9793, 04-9009,
04-9830, 04-9753**

Telamatto, leveys cm, pituus cm , puikot kpl

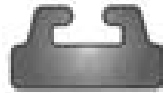

30-21	L=140 cm musta
30-621	L=140 cm grafiitti
30-210	L=163 cm musta
30-321	L=140 cm keltainen

OBS!

**Denna sida och 2000 andra liknande om alla
märkerna finns på våran hemsida.**

www.teolehtimaki.fi/varaosaluettelot

3700-3800 r/min, kytkentäkierrosluku
7900-8000 r/min, max. kierrosluku

Voimansiirto / Teo Lehtimäki Oy

P50- korvaa alkuperäisen



15-19 (0019)
Kal: 7009
Jousi: 0451-1118
Jousi: 15-54
Shims: 5 + 1

Sähköosat

05-B8 sytytystulppa
01-14342 CDI yksikkö
01-15416 tasasuuntaaja, E-mallit
01-15415 jännitteensäädin
01-14355 puola

Sukset

Peltisuksi

32-99 Suksimuovi
33-20 CTRL levike 180 mm
MM142 Kovametalli

Muut osat / Teo Lehtimäki Oy

**Dessa sidor
uppdateras
kontinuerligt**

04-6370

60 x 372 cm B = 74 st
Nordik 600 SLE

Nyhet



Innehållsföteckning

- 5- 8 **Finska mattor**
- 9-11 **Camoplast mattor**
- 17-19 **Förlängnings satser, mattskoning**

- 20-21 **Drivhjul**
- 22-23 **Kugghjul, boggiehjul**
- 24-25 **Glidskenor**
- 26-27 **Boggie fjädrar**
- 28 **Axlar, Syncro, Dragkrok**
- 29 **Bränsle pumpar**
- 30-33 **Skid plast**
- 34-39 **Styrstål**
- 40-48 **Variatorer, sekundär**
- 49-52 **Ramlager, nållager**
- 53 **Förgasargummi**
- 54-55 **Packningsatser**
- 56-62 **Kolvar, Kolvbultar,**
- 63 **Vindrutor**
- 64-65 **Bromsbelägg**
- 65-67 **Kedjor, Silent, Hyvö**
- 68-71 **CDI boxar, Tändspolar,**

Bombardier museo, Valcourt



Bredd 38 cm

A = 50 mm



Lynx, Winha, Skidoo, Nordik 300, R, 377R

04-3315	38 x 315 cm	B = 63 st
04-3333	38 x 330 cm	B = 66 st
04-3357	38 x 353 cm, Elan	B = 70 st
04-3392	38 x 392 cm	B = 78 st

Ockelbo

Lynx 320 ja 330 modeller

04-3375	38 x 375 cm	B = 75 st
----------------	-------------	-----------

Om måttet **A** är 70 mm, med att byta hjul kan mattan monteras



Kuggjul för 27 mm
hexa axel
37-04



Kuggjul /
Vändhjul
37-03



Vändhjul
20-5287

Bredd 50 cm

A = 50 mm



Lynx

Winha

04-5330

50 x 330 cm

B = 66 st

04-5370

50 x 372 cm

B = 74 st

04-5392

50 x 392 cm

B = 78 st

Om måttet **A** är 70 mm, med att byta hjul kan mattan monteras



Trapper

04-5372

50 x 372 cm

B = 74 st

04-5382

50 x 382 cm

B = 76 st



Nordik (ej hjulbyte)



Bredd 60 cm



04-6340	60 x 340 cm	B = 67 st Lynx Finlandia, Winha 60
04-6372	60 x 372 cm	B = 74 st Lynx 635, Ockelbo 6000, Trapper 6000
04-6380	60 x 382 cm	B = 76 st Lynx 650 S Glidboggie

Ockelbo 600



04-6000 **HSB 54**
enkeldrift

Arbetskottrar

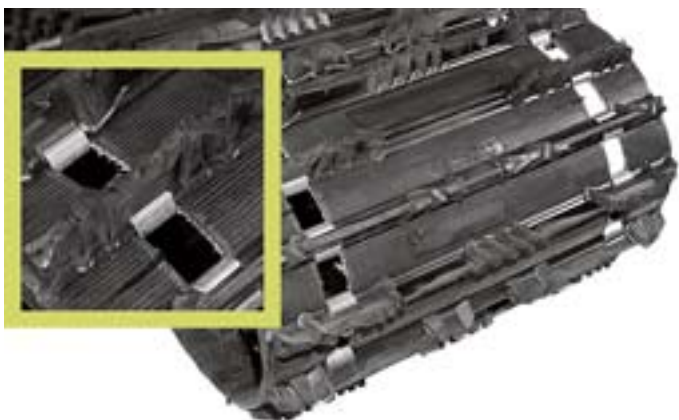

Rip Saw Full clip deln. 2,52"			
Nummer	bred	längd	kam
	cm	cm	mm
04-9002	50	396	32



Rip Saw Full clip deln. 2,86"			
Nummer	bredd	längd	kam
	cm	cm	mm
04-9089	50	392	38

Ice Tech, med dubbar			
Nummer	bredd	längd	kam
	cm	cm	mm
04-9002	50	396	32

Beantat, Scandik WT. Lynx, Polaris, Yamaha Viking



Explorer 25 mm Full clip			
Nummer	bredd	längd	kam
	cm	cm	mm
04-9806	38	396	25

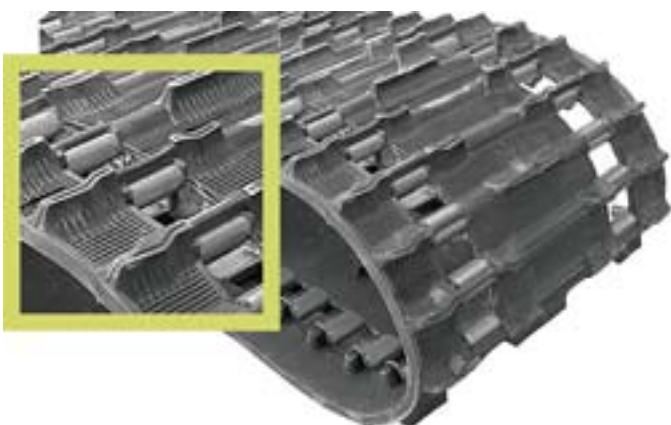

Explorer 19 mm full clip			
Nummer	bredd	längd	kam
	cm	cm	mm
04-9011	38	353	19

Kam 19 mm, , Elan, Safari, Lynx, gamla modeller



Durasport 15 mm full clip			
Nummer	bredd	längd	kam
	cm	cm	mm
04-9755	38	290	15
pyöräteli soljet			
04-9756	38	290	15
liukuteli soljet			

Durasport 15 mm full clip			
Nummer	bredd	längd	kam
	cm	cm	mm
Cheyenne			
04-8000	42	353	15

Kam 25 mm,

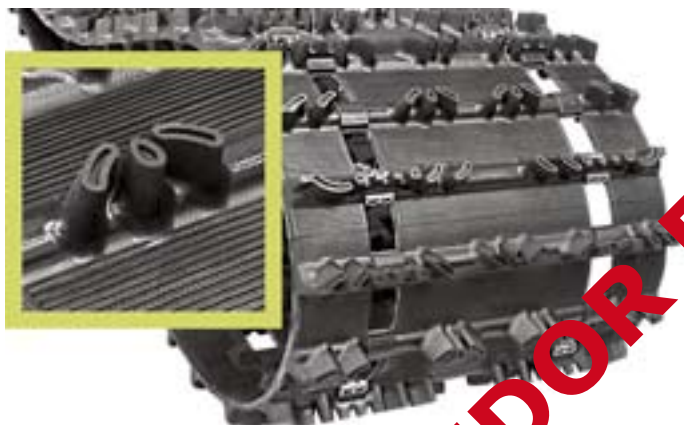

Hack Saw 25 mm full clip			
Nummer	bredd	längd	kam
	cm	cm	mm
04-9009	38	307	25
04-9010	38	345	25

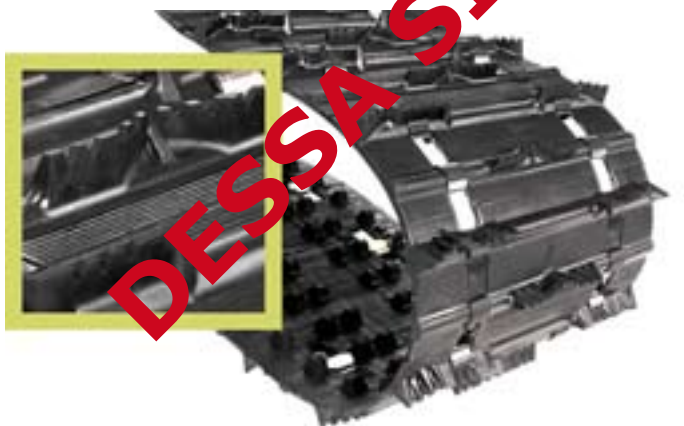

Challenger 25 mm 2/1 clip			
Nummer	bredd	längd	kam
	cm	cm	mm
04-9793	38	307	25
04-9794	38	345	25



Durasport 25 mm full clip			
Nummer	bredd	längd	kam
	cm	cm	mm
04-9753	38	307	25
04-9863	38	345	25

Special mattor



Yamaha, Polaris

Free ride 38 mm full clip			
Nummer	bredd	längd	kam
	cm	cm	mm
04-9033	36	307	38
04-9034	36	345	38



Arctic Cat

Hack Saw 25 mm full clip			
Nummer	bredd	längd	kam
	cm	cm	mm
04-9960	34,3	325	25



TRACtion Control System

Rip Saw 32 mm full clip			
Nummer	bredd	längd	kam
	cm	cm	mm
04-9955	38	307	32



Mjuk gummiblandning

Predator 32 mm 2/1 solki			
Nummer	bredd	längd	kam
	cm	cm	mm
04-9828	38	307	32

Rip Saw mattor



Deln. 2,52"

Rip Saw 32 mm



Rip Saw 38 mm



Rip Saw 32 mm			
Nummer	bredd	längd	kam
	cm	cm	mm
04-9921	38	307	32
04-9040	38	325	32
04-9922	38	345	32
04-9006	38	365	32
04-9007	38	385	32
04-9925	38	403	32
Special bredd			
04-9001	34,3	325	32
04-9021	40,5	345	32
Delning 2,86"			
04-9049	38	305	32
04-9080	38	348	32
clip	full clip		
clip	var tredje, alla öppna		
clip	var tredje		

Ice Ripper, deln. 2,52"

Ice Ripper 32 mm clip 2/1			
Nummer	bredd	längd	kam
	cm	cm	mm
04-9993	38	307	32

Ice Ripper , deln. 2,86"

Ice Ripper 32 mm full clip			
Nummer	bredd	längd	kam
	cm	cm	mm
04-9041	38	305	32
04-9042	38	345	32

Rip Saw 38 mm full clip			
Nummer	bredd	längd	kam
	cm	cm	mm
04-9112	38	307	38
04-9045	38	325	38
04-9113	38	345	38
solki	var tredje, alla öppna		



Cobra 34 mm fullclip deln 2,52''			
Nummer	bredd	längd	kam
	cm	cm	mm
04-9052	38	307	34
04-9081	38	325	34
04-9061	38	345	34



Cobra 34 mm fullclip deln 2,86''			
Nummer	bredd	längd	kam
	cm	cm	mm
04-9092	38	305	34
04-9093	38	348	34
04-9094	38	370	34



Sokosti 38 mm full clip			
Nummer	bredd	längd	kam
	cm	cm	mm
04-9003	38	365	38
04-9004	38	384	38
04-9005	38	403	38
solki	var tredje, alla öppna		

Intense 38 mm full clip			
Nummer	bredd	längd	kam
	cm	cm	mm
04-9930	38	307	38
Obs: ej mjuk gummi			
04-9108	38	345	38

Deln 2,86''



Rip Saw 44 mm full clip			
Nummer	bredd	längd	kam
	cm	cm	mm
04-9075	38	305	38
04-9076	38	348	38
04-9090	38	305	44
04-9095	38	305	44
04-9096	38	348	44
04-9121	38	370	44

Back Country deln 2,52" Förnyat mönster och gummiblandning



Back Country 44 mm full clip			
Nummer	bredd	längd	kam
	cm	cm	mm
04-9140	38	307	44
04-9141	38	325	44
04-9142	38	345	44
04-9142	38	365	44

Deln. 2,86"



Challenger 44 mm full clip			
Nummer	bredd	längd	kam
	cm	cm	mm
04-9069	40,5	305	44
04-9070	40,5	348	44

deln. 2,86"



Challenger 51 mm full clip			
Nummer	bredd	längd	kam
	cm	cm	mm
04-9086	38	348	51
04-9087	38	370	51
04-9088	38	391	51

Deln. 2,86"



Challenger 63 mm full clip			
Nummer	bredd	längd	kam
	cm	cm	mm
04-9102	40,5	394	63
04-9103	40,5	414	63

Deln. 2,52"



Finger design 51 mm full clip			
Nummer	bredd	längd	kam
	cm	cm	mm
04-9889	38	365	51

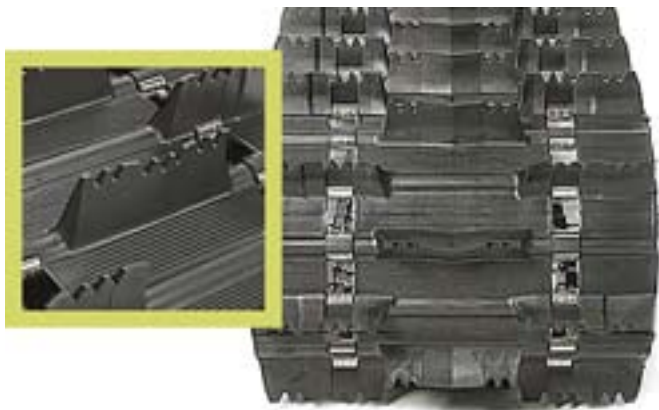

Deln. 2,52"

Challenger 51 mm full clip			
Nummer	bredd	längd	kam
	cm	cm	mm
04-9798	38	307	51
04-9797	38	345	51
04-9875	38	365	51
04-9876	38	384	51
04-9808	38	396	51
04-9899	40,5	365	51
04-9919	40,5	384	51
04-9941	40,5	403	57



Deln. 3,00"

Challenger 44 mm full clip			
Nummer	bredd	längd	kam
	cm	cm	mm
04-9933	40,5	345	44

Challenger 59 mm full clip			
Nummer	bredd	längd	kam
	cm	cm	mm
04-9099	40,5	345	59



Deln. 3,00"

Challenger 63 mm full clip			
Nummer	bredd	längd	kam
	cm	cm	mm
04-9942	38	365	63
04-9943	38	411	63

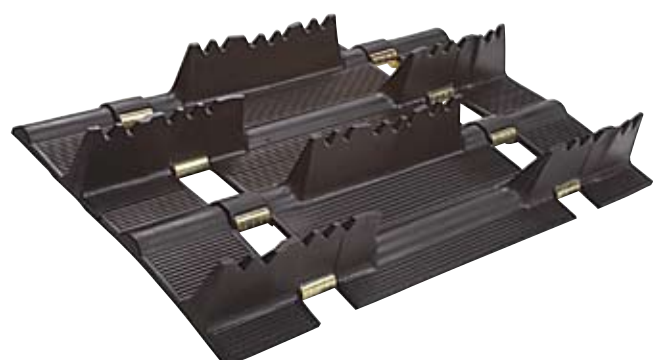

Challenger 57 mm full clip			
Nummer	bredd	längd	kam
	cm	cm	mm
04-9984	38	358	57
04-9985	38	388	57

Maverick

Next generation Mountain Track designed to provide outstanding performance in deep bottomless powder, while maintaining transit capability on hard pack.

NEW



3"

Top portion of profile designed to bend, compacting snow versus "cutting" and trenching, providing optimal performance in powder.



Rigid columns, "fingers" strategically positioned at the ends of profiles provides optimum performance in hard packed snow.

57 mm

04-9025	38 x 388 cm	57 mm	Deln. 3"	full clip
04-9030	40,5 x 411 cm	57 mm	Deln. 3"	full clip
04-9047	36 x 384 cm	57 mm	Deln. 2,52"	full clip



63 mm

04-9942 38 x 365 cm
Deln. 3" full clip

2,86"

Challenger Ext 57 mm full clip			
Numero	bredd	längd	kam
	cm	cm	mm
04-9064	40,5	371	57
04-9065	40,5	391	57
04-9066	40,5	414	57

Förlängningsseter

04-3050
Universal 12 cm



04-3060
Yamaha 12 cm



04-3080
Yamaha 20 cm



04-3300
Lynx 20 cm

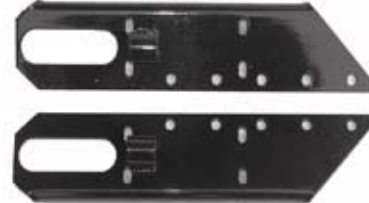

04-3040
Universal 25 mm axel
20 cm förlängning



04-3070
Förkortningsats. G-type.
320 cm kan förkortas till
307cm

04-3000



Aluminium profiler



04-3001

Chassie 400-420 mm
längd 400 mm



04-3003

Chassie 415-430 mm
längd 400 mm

04-3002

chassie 400-410 mm
längd 200 mm

Mattskoning

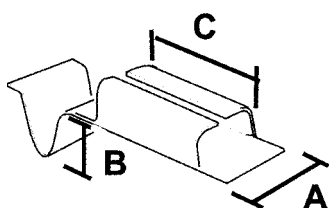

p/n	A	B	C
38-01	18	-	30
38-02	21	-	30
38-03	20	16	30
38-04	23	18	21
38-05	21	-	38
38-06	22	19	38
38-07	21	-	19
38-08	22	-	20
38-09	19	14	25
38-10	19	-	25
38-11	19	16	37

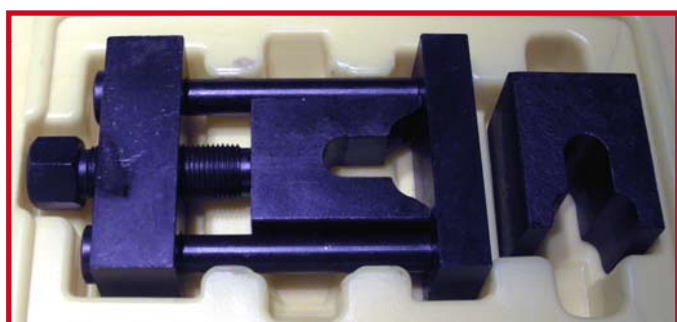
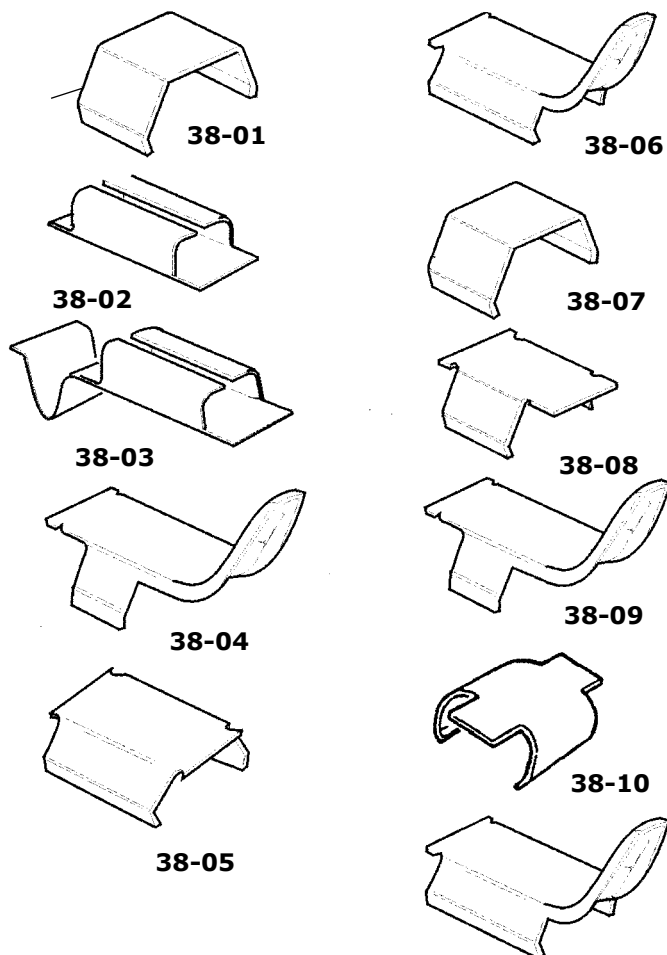

Verktyg, passar på alla
Camoplast mattskoningar

prod. nummer: 38-100

(04-9925) + (04-3000) = 403 cm



365 cm



384 cm



Lynx 04-9040

38 x 325 cm



Original mattan 320 cm
eller 330 cm lång

**Tillräckligt justeringspel men
förlänga hålet ca. 5 mm.**



No Slip drivhjul,

patent by Wahl Bros.



21-08PO

Nummer	kuggar	deln	ytter dia	axel / mm	hål
39-00	7	2,52"	136 mm	25,0-27,0	24,0 mm
39-01	7	2,52"	136 mm	27,0-29,0	26,0 mm
39-02	7	2,52"	136 mm	32,0-34,0	31,0 mm
39-05	8	2,52"	158 mm	25,0-27,0	24,0 mm
39-06	8	2,52"	158 mm	32,0-34,0	31,0 mm
39-08	8	2,52"	158 mm	27,0-29,0	26,0 mm
39-09	9	2,52"	177 mm	27,0-29,0	26,0 mm
39-10	10	2,52"	197 mm	27,0-29,0	26,0 mm
39-15	7	2,86"	155 mm	25,0-27,0	24,0 mm
39-17	7	2,86"	155 mm	27,0-29,0	26,0 mm
39-18	8	2,86"	181 mm	27,0-29,0	26,0 mm
39-26	7	3,00"	163 mm	32,0-34,0	31,0 mm
39-27	7	3,00"	163 mm	27,0-29,0	26,0 mm
39-28	8	3,00"	190 mm	27,0-29,0	26,0 mm
39-38	8	3,00"	190 mm	rör axel	Skidoo, Lynx
21-08PO	8	3,00"	190 mm	rör axel	Polaris

Anti-Stab system



39-791 Center, 223 mm axel
Arctic Cat, Yamaha

39-793 Center, 220 mm axel
Skidoo, Polaris, Lynx

Kuggghjul / Drivhjul

Nummer	Kuggar	Delning	Lager	OBS!!!
20-5285	9	50 mm	35-6205	Ockelbo, bredd 25 mm
20-5286	9	50 mm	35-6205	Ockelbo, Trapper, bredd 30
20-5287	11	50 mm	35-6205	Lynx, Nordik 300
20-5288	10	50 mm	35-6205	Nordik PSS, 540, 550
20-5289	9	2,52"	35-6205	för mattan 9806, 9925, 9005
37-00	9	50 mm	-	drivhjul, bredd 22 mm
37-01	9	50 mm	-	drivhjul, bredd 30 mm
37-03	11	50 mm	-	drivhjul, bredd 30 mm
37-04	11	50 mm	sexkant 27mm	drivhjul, bredd 30 mm
37-06	-	-	-	Boggiehjul för metalflänsar 127mm



37-03



37-04



20-5285, 20-5286



20-5287



20-5288

Drivhjul, normal



20-5289

Nummer	Kuggar	Delning	Ytter dia	Axel / mm	Sexkant hål
21-07N	7	2,52"	136 mm	fyrkant	fyrkant 21,0
21-07K	7	2,52"	136 mm	25,0-27,0	24,0 mm
21-07G	7	2,52"	136 mm	27,0-30,0	26,0 mm
21-08AC	8	2,52"	158 mm	25,0-28,0	24,0 mm
21-08LY	8	2,52"	158 mm	32,0-34,0	31,0 mm
21-09PO	9	2,52"	177 mm	25,0-28,0	24,0 mm
21-09LY	9	2,52"	177 mm	32,0-34,0	31,0 mm

Boggie Hjul

Nummer	Dia	Lager	Färg	passar:
20-108	108	35-620258	svart	Skidoo, Lynx, Polaris
20-117	117	35-6205	svart	Polaris
20-127	127	35-620258	svart	Lynx
20-130	130	35-6004	svart	Yamaha
20-133	133	35-6004	svart	Lynx, Ockelbo
20-135	135	35-6205	silver	Skidoo, Trapper, Nordik
20-135F	135	35-6205	silver	Full moon, Skidoo
20-5350	135	35-6205	silver	Polaris, insats hylsor
20-5630	143	35-6205	svart	Arctic Cat
20-5630H	143	35-6205	silver	Arctic Cat
20-5630G	143	35-6205	grön	Arctic Cat
20-155	155	35-6205	svart	Skidoo, Trapper, Nordik
20-6380H	160	35-6205	silver	Polaris, Arctic Cat
20-6375S	160	35-6205	blå	Polaris, Arctic Cat
20-6375P	160	35-6205	röd	Polaris, Arctic Cat
20-165K	165	35-6205	gul	Lynx
20-165P	165	35-6205	röd	Lynx
20-165H	165	35-6205	silver	Lynx
20-180	180	35-6205	silver	Lynx, 04-3000 flippen
20-131	180	35-6204	svart	Yamaha
20-190	190	35-6205	svart	Skidoo



Insat hylsor		
20-34	hylsa 3/4 "	par
20-58	hylsa 5/8 "	par



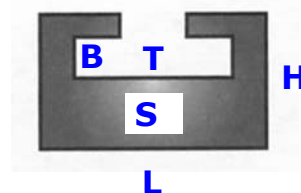
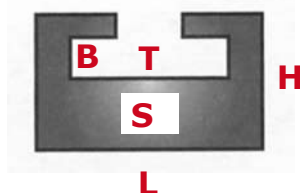

Glidskenor

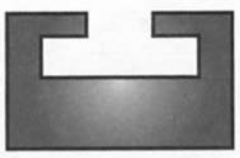

Arctic Cat	Bredd L mm		Höjd H		Tjoklek S	B ,mm	T ,mm
	30		20		9,5	5	19
	Nummer	Längd cm	Färg	Arctic Cat, alla modeller efter -78			
	30-10	140	svart				
	30-610	140	grafit				
	30-410	163	orange				
	30-167	167	svart	Arctic Cat, Super Jag, Karibo			

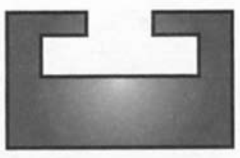
Skidoo, Lynx	Bredd L mm		Höjd H		Tjoklek S	B ,mm	T ,mm
	37,5		19		10	5	26
	Nummer	Längd cm	Färg				
	30-01	140	svart	Lynx, kaikki G-typeen saakka, sitten			
	30-601	140	grafit	työkelkat			
	30-010	163	svart	Skidoo gamla mod., till -96			
Trapper, Nordik	Trapper, Nordik-300,500,600						

Skidoo Nordik	Bredd L mm		Höjd H		Tjoklek S	B ,mm	T ,mm
	37		20		10	7	24,5
	Nummer	Längd cm	Färg	Nordik 377 R, 540, 550			
	30-00	155	vit.				

Skidoo, Lynx	Bredd L mm		Höjd H		Tjoklek S	B ,mm	T ,mm
	38		17		9,5	4,5	22
	Nummer	Längd cm	Färg				
	30-21	140	svart	Lynx G-type från och med			
	30-621	140	grafit	Skidoo REV, RT & RF, SC4 boggie			
	30-210	163	svart				
	30-321	140	gul.				

Skidoo, Lynx	Bredd L mm		Höjd H		Tjoklek S	B ,mm	T ,mm
	38		15		7	5	27
	Nummer	Längd cm	Färg	Formulat, GT mod., Mach1, Z, MXZ,			
	30-260	140	svart	Legend, MX Rev, Summit, Renegade			
	30-360	140	gul.				
		Lynx 2009- RS 600, SC 4 boggie,					

Glidskenor

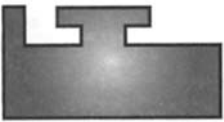
Polaris	Bredd L / L mm		Höjd H		Tjoklek S	B ,mm	T ,mm
	31	37			11		
	Nummer	Längd cm	Färg				
	30-15	140	svart		Alla modeller t.om 2000,		
	30-615	140	grafit		XTRA 10, XTRA 12 smal profil		
30-150	145	svart					
Obs: mått	30-618	140	grafit		Polaris- Storm, XCR, bred profil		

Polaris	Bredd L mm		Höjd H / H		Tjkl. S / S	B / B	T / T
	32		19,5	22,0	9 / 11	5 / 6	22 / 23
	Nummer	Längd cm	Färg		Edgr RMK 03-05, Edge 2000-05,		
	30-23	140	svart		340 mod -99-05, Lite 97-98		
	30-623	140	grafit		Indy Sport -97-99,		
30-230	167	svart		2000-			
Obs: mått	30-240	163	svart		gen II RMK, XC, M-10 , Indy Edge		

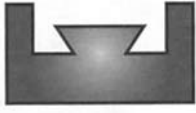
Yamaha	Bredd L mm		Höjd H		Tjoklek S	B ,mm	T ,mm
	30				7		
	Nummer	Längd cm	Färg		Phaser, Ovation, SRV, SS		
	30-12	140	svart				
	30-612	140	grafit				

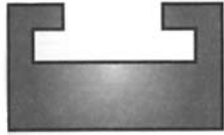
Yamaha	Bredd L mm		Höjd H		Tjoklek S	B ,mm	T ,mm
	30		15		7	5	24
	Nummer	Längd cm	Färg				
	30-16	140	svart		Viking, Exciter 87-90, Phaser 90-99		
	30-616	140	grafit.		V-max 92-97,		
				V-max 500-600 94-96			

Yamaha	Bredd L mm		Höjd H		Tjoklek S	B ,mm	T ,mm
	30		18		10	5	24
	Nummer	Längd cm	Färg				
	30-20	140	svart.		V-max 97-03,		
	30-200	145	svart		Mountain max 97-02		
30-620	140	grafit		SX, SRX, SXR, 98-04			

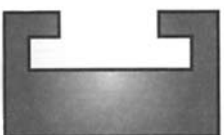
Yamaha	Bredd L mm		Höjd H		Tjoklek S	B ,mm	T ,mm
	34		18		10	5	25
	Nummer	Längd cm	Färg				
	30-625	145	grafit		RX1 mod. 2005- RS mod. 2005-		
					Apex, Attack 2006-		
				Nytro 2006-			

Startfjäder



01-1560	Rotax	414 783 400
01-158	Rotax	420 939 115
01-2080	Arctic Cat Polaris Yamaha	3001-077 308-3185 8YO-15713-00-00
01-2083	Arctic Cat Polaris	3002-921 308-3495
01-206	Sachs	
01-207	Kohler	

Startklacksatser Rotax



01-153



01-154

Framfjäder



41-3281	8,0mm	mm. Lynx 250,3900
41-3000	9,0mm	t.e.x. Lynx 5900



41-8797	10mm	mm. Ranger King 538797, 538798
----------------	------	-----------------------------------

41-8796	9,0mm	538796, 538795
----------------	-------	----------------



41-1530	9,0mm	Lynx 5900, krok och ring
----------------	-------	--------------------------

40-4715	8,5mm	Nordik 500, 540, 550, 600
----------------	-------	---------------------------



40-CA	8,0mmmm.	Karibo, Arctic Cat
--------------	----------	--------------------

parvis

Bakfjäder

parvis



40-PZ Yamaha Phazer 07-
ca. 20 % starkare



40-LT Yamaha Mt. Lite
kortare tråd 50 mm längre än 40-PZ

Bakfjäder

parvis



40-AC 11,5 mm
Arctic Cat senaste modeller



40-POLA 11,5 mm
8 varv lindat
Polaris, Skidoo, Lynx



40-VI 12,0 mm
Yamaha Viking



40-PO 11,5 mm
9 varv lindat
Polaris från 1990



40-EDGE 11,0 mm
Polaris EDGE boggie



40-POL 11,5 mm
Polaris till 1989 med krok

Bakfjäder / standard

/ parvis



41-8805 Lynx Ranger mm.



41-4175 Lynx 3900 S



40-4721 Nordik 500-600



41-1531 Lynx



41-4277 Lynx 10,0 mm



41-4500 Lynx 9,0 mm



40-4716 Nordik

Fjädrarna på bilderna är högerlindade

Driv axel 5900

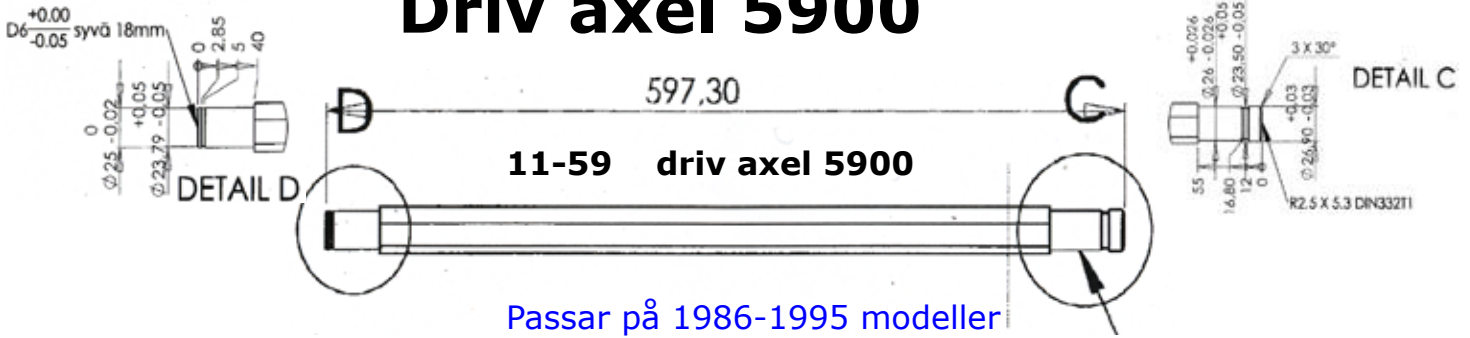

Boggie axel



11-02	3450701	Lynx 250, 360
11-03	3501775	Lynx GLX, 5900, 650
11-04	3501911	Lynx GLX, 5900, 650
11-08	5492814	bak axel Lynx 250
11-09	5493615	bak axel Lynx 5900
11-10	5496216	bak axel Lynx 360, 3900
11-11	05032390	bak axel Nordik 500, 540
11-12	05032389	bak axel Nordik 300, 377R

Variator axel, hylsa



11-20	5394111	Lynx 250S, 3900S
11-21	5398073	Lynx 360S, Ranger
11-22	539990	Fox -99
11-23	5146138	Fox 00-
11-25	875138073	Syncro



Syncro drevsats

43-65	1992 fr.m
nedre, bred	z=64 8751-55048
mellan, vänster	z=33 8751-47643
mellan, höger	z=33 8751-47644
43-64	till 1992
nedre, bred	z=64 8751-55048
mellan, vänster	z=31 8751-47202
mellan, höger	z=31 8751-47203

Nyhet



Sisu växellåda, drev

43-66	1996-2003
nedre	Z=55 8751-56048
mellan	Z=31 8751-56049
nedre	Z=28 8751-56050

Tätningar



- 08-101 Rotax 377-447-503 avgasrör
- 08-100 Rotax 377-447-503 insugningsrör
- 08-102 Polaris avgasrör

Rep sats.

(MIKUNI)



- 08-103 Mikuni (07-187-05)
- 08-104 Mikuni (07-187-11)



03-7000 Primer pump



03-7311 Filter

Förlängning av gasvajer

03-5000 Throttle extension kit ca.20 cm



Bränsle pump



08-188



08-200



08-187

Drag krog



12-01



12-02 Skidoo



12-03 Polaris



12-04 Skidoo
12-04XP Skidoo -09-

Extra breda belag design model

31-01	Bredd	250 mm	8 mm	Polaris 08-
31-02	Bredd	200 mm	8 mm	
31-03	Bredd	230 mm	8 mm	
31-09	Bredd	230 mm	8 mm	
31-00	Alpine II		8 mm	
31-04	Bredd	195 mm	8 mm	



31-01 Vuotsolainen **31-02** Vuotsolainen



31-03 Vuotsolainen

Passar utmärkt också på andra skidor (till exempel Arctic Cat)

31-04

**Vuotsolainen för Pilot/ Polaris skida
design skyddad / Yamahan skida
bredd 195 mm, 8 mm**



**Kan använda 1, 2,
eller 3 styrstål, men
en är tillräckligt**



31-04 Vuotsolainen för pilot skida

**31-03L / vänster
31-03R / höger**

230 mm

Vuotsolainen för pilot skida

230 mm

Vuotsolainen för pilot skida



31-05 Yamaha Viking, förborrat hål



33-50 Smal Pilot skida

Skidbelag för plastskidor



33-10 Arctic Cat



33-30 Katamaran skidan



33-40 Polaris



33-60 Skidoo / Lynx flex



**33-20 CTRL skida,
ej förborrat, passar på andra mod.**



33-50 Pilot, smal model



33-70 Skidoo1996-



33-80 Yamaha SRX 1998-



**33-90 Yamaha 2000 / Skidoo / Lynx
passar till många andra modeller**



**33-99 Yamaha RX-1
text 33-99 mellan bakre hål och
text 33-90 YA, liten, liten text.**

**31-06 Bukplast
6 x 800 x 1000 mm**

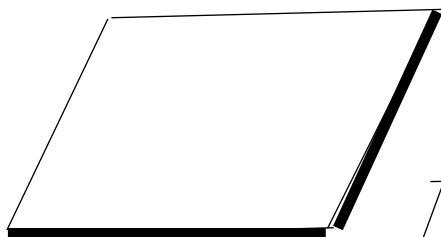

31-00 Alpine II



Titta plastbelag på vårans
hemsida.

www.teolehtimaki.fi

Plast yta

31-07

8 x 150 x 3000

31-08

8 x 150 x 2000







Skidbelag 8 mm HPDE.



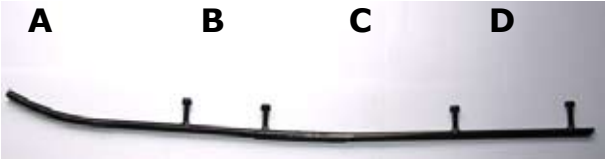

 <p>32-01 Arctic Cat</p>	 <p>32-06 Arctic Cat</p>
 <p>32-00 Ockelbo</p>	 <p>32-11 Trapper, Nordik</p>
 <p>32-99 Safari, Scandic 380</p>	 <p>32-21B Formula, Snowexpert</p>

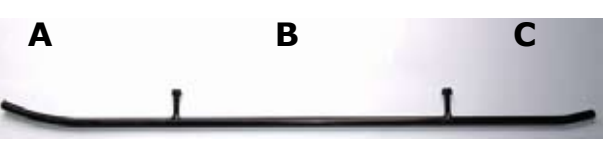
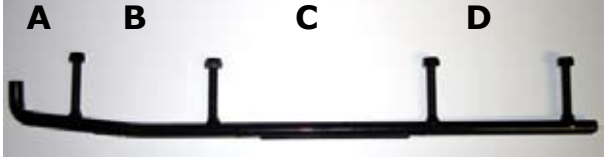
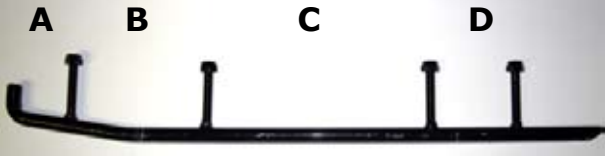

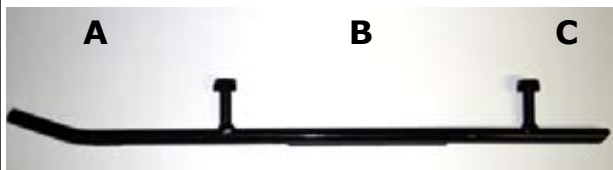
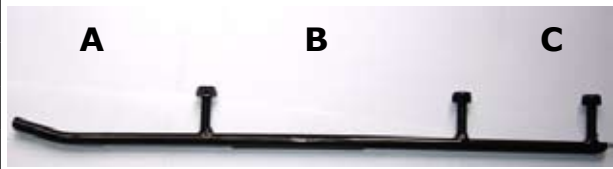
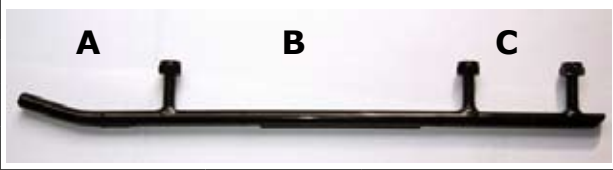

Med den här skidan passar vanligt styrstål **MM277** och Coromant **MM147 33-90** passar på den här smala skidan utmärkt.

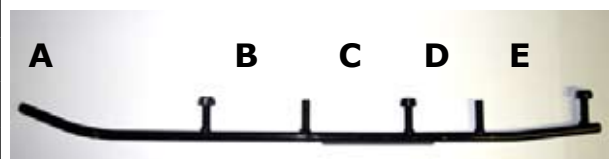
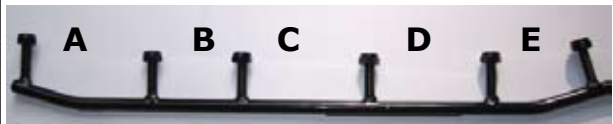
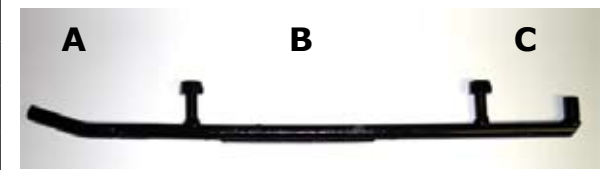
 <p>32-61 Lynx</p>	 <p>32-41 Polaris 1993-</p>
 <p>32-51 Polaris -92, Ockelbo</p>	 <p>32-81 Yamaha Viking</p>
 <p>32-88 Yamaha Phaser 98-</p>	 <p>32-91 Yamaha V-max</p>

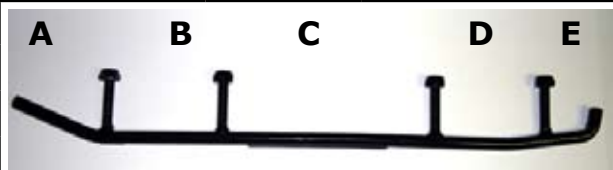

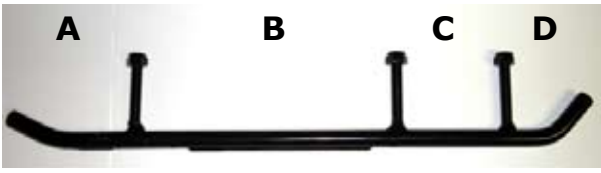
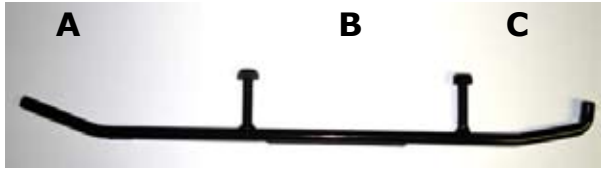

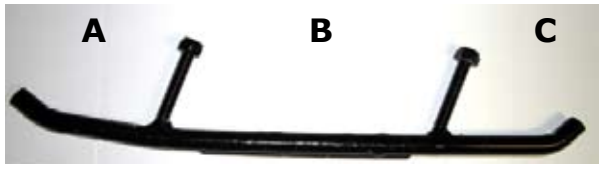
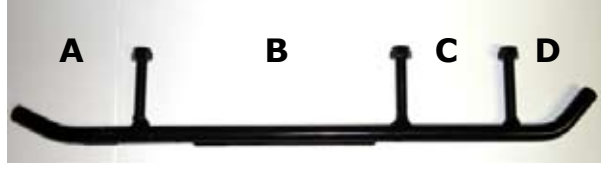
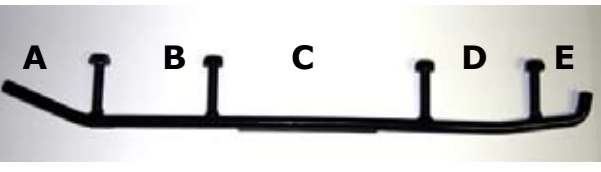
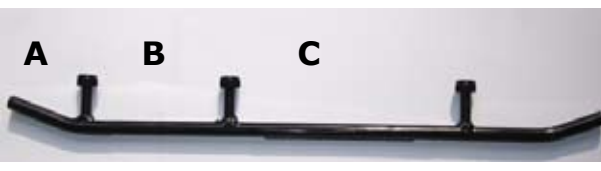
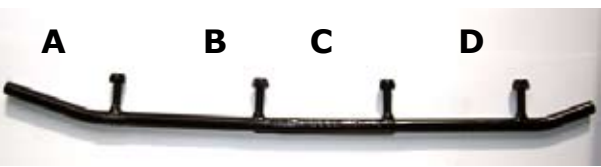
Järn	Racing	Coromant	L=Längd	A	B	C	D	E	
MM203		MM169	772	386	386	-	-	-	
			AKTIV: Alaska, Panther, Karibo 1984-1986, och ARCTIC CAT: El Tigre 1980-84, Jag 1980-91, Panther 1980-89, Super Jag 1987-92 Trail Cat 1980-81, Pantera 1980-85						
MM205		MM170	776	343	433	-			
			Cheetah Tour 1987-91, Cougar 1987-91 El Tigre 1987-90, Jag AFS 1989-91 Manx 1991-, Pantera 1987-90 Panther 1990-91, Wild Cat 650 1988-90						
MM260		MM133	787	260	108	249	162		
			Ext Special 1992, Ext 580,Z 1993-94, Jag Special, Z 1992, Prowler Spec. 1992-94 Wild Cat 700 EFI 1992-94, ZR 440 1993-95 ZR 580,700 1993-95, Thunder Cat 1996						
MM210		MM173	610	356	127	114			
			Bear Cat 340,440 1995-99, Cheetah Tour 1992-94 Cougar 1992-97, Ext, EFI 1992-93, Manx 1992-93 Jag AFS DL 1992-93, Prowler 2-UP 1992-94 Pantera 1992-97, Panther 1992-93, Prowler 1991-96 Thunder Cat 1993-95 Puma 1991-97, Wild Cat EFI 1992						
MM261			791	236	380	193			
			El Tigre 1985-86 Cougar 1985-86 Cheetah 1986 Pantera 1986						
MM262		MM157	469	57	114	178	114		
			Plast skidor 1996-						
MM263		MM158	469	57	114	178	70		
			Plast skidor 2005-???						
SLP skida			SLP skida						
MM290	MM390	MM190	470	89	179	90	112		
			SLP skida						
Valokuvatuissa raudoissa etupää aina vasemmalla, kaikissa.									

Järn	Racing	Coromant	L=längd	A	B	C	D	E	
MM242		MM189	470	170	235	65			
			Forest Fox 1999-, GL360, 250 1991-93, GL 2300 -90 GL 3300 1989-90, GL 3900, LTS 1991-92 GLS 3900 1989-90, GLX 5900, LTS 1991-93 GL Sport, LTS 1991-92, Ranger 1993						
MM230		MM187	550		235				
			GL 250. 250S 1986-89, GL 3900 1983-88 GL 5900 1983-90 535, 650 1983-87 640 1988						
MM240		MM188	450		228	81			
			GLS 3300 1986-89, GLS 3500 F/C 1990-93 GLS 3600 L/C 1990-91, Cobra 1992-93 3800 Rave, Ultra, Cobra Touring, Rave , Cobra Racing, Enduro 1993						
MM241			450		219				
			230, 250, 650 1989-93						
MM265		MM154	660	215	110	114	80	122	
			G-type Rave 1997-99 Enduro 600						
		MM153	530	120		115	110	80	
			G-type Racing 1998- Sport XR 98						
		MM152	440	130	228	77			
			G-type 1997-99 Enduro 500						
MM250		MM193	625	321	241	63			
			Ranger kort stålskida av Skidoo 2000-						
MM279		MM146	537	90	103	190	103	54	
			FLEX plast 2000- Samma skida, Skidoo						

Järn	Racing	Coromant	L=Längd	A	B	C	D	E	
MM277		MM147	400	87	177	75	60		
			Plastskida, Camoplast skida 2003- Också Skidoo och Polaris						
MM243	MM386	MM186	520	210	192	121			
			ADJ skida, CTRL skida 2003-						
MM255			520		192				
			ADJ med tre bultar						
SKI-DOO									
MM274		MM144	335	89	160				
			Pilotti skida/ Skidoo, smal och bred						
MM277		MM147	400	87	177	75	60		
			Plast skida, Camoplast 2003- Också Lynx och Polaris Skandic 380-550 2003-						
MM279		MM146	534	84	103	190	103	54	
			Plast skida FLEX 1997- Också Lynx						
		MM141	445	54	95	222			
			Formula 583 1998 Formula III 600, 700 1997-99 Formula Mach I, Z 1997-99, Formula Z 1997-99 G-Touring 583, 670 1997-99, Summit 1997-99						
		MM142	502	90	126	110	116	60	
			MXZ 440, 583, 670 1996-99						

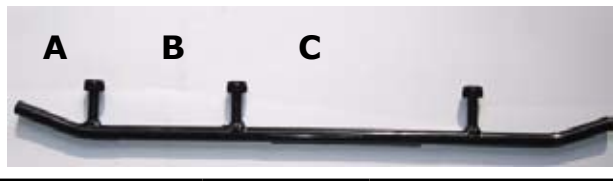
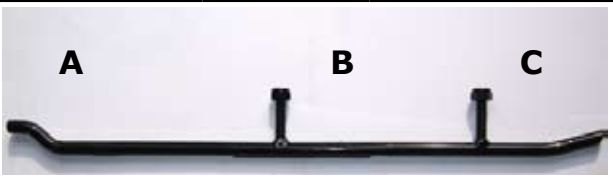
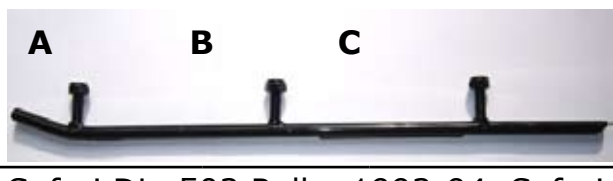
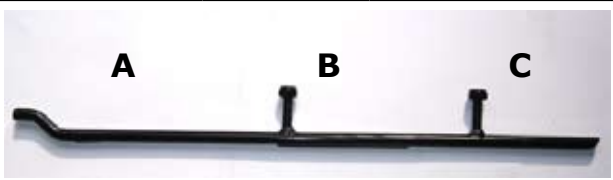
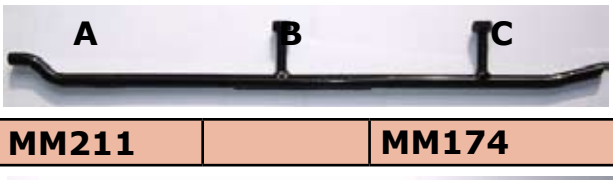
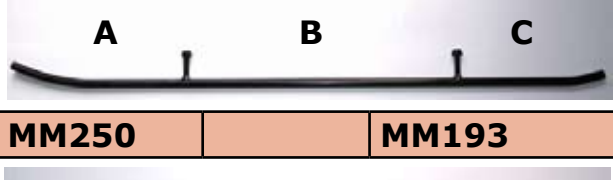

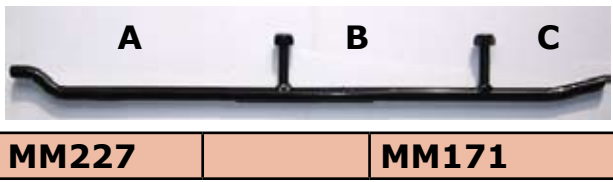



SKI-DOO



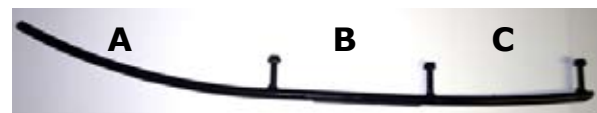
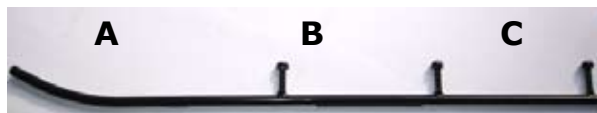
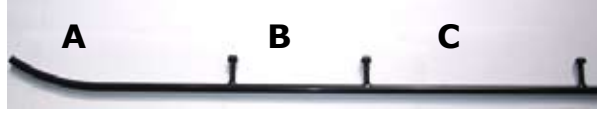

Styrstål

Järn	Racing	Coromant	L=Längd	A	B	C	D	E	
		MM143	495	54	120	196	115		
			Formula III 1985-96, Formula Mach Z 1985-96 Formula MXZ 1993-95, Formula Z 1994-96 G-Touring 583, 670 1993-96 Summit 1994-96						
MM229			602	248	176				
			Formula SP DL 1985-86, Tundra 1985-97 Safari 377, 447, 503 1984-88 Safari, Saga, Scout 1989-92 Skandic 377, 503 1986-87						
MM216		MM163	602		170	170	99		
			Formula Mach I 1989-94, Formula SS 1995-96 Formula MX, XTC 1985-95 Formula Plus, XTC 1985-93 Formula ST, STX 1994-96, Grand Touring 470 -95 Safari DL, 503 Rally 1993-94, Safari GLX, LCE, L 1990-94, Skandic II 377, 503 92-94						
MM275		MM145	545		178	114			
			Blizzard 1978-84, Nordik 1981-83 Everest 1974-83, Olympique 1976-79 Skandic 277, 377 1982-85 TNT 1973-78						
MM215		MM176	527	238	177	112			
			Safari Cheyenne 1989-91 Alpine II 1991-95						
MM211		MM174	483	162	178				
			Citation 1980-91 Elan 1971						
MM250		MM193	625	321	241	63			
			Formula 500, DL 1996-99 Formula 583 1996-99, Formula S, SL, SLS 95-99 G-Touring 500 1996, Scandic 380, 500 1995-						
TRAPPER, NORDIK									
MM215		MM176	527	238	177	112			
			Nordik 300-377 Nordik 500-600 Nordik 540-600 SL						
MM227		MM171	480	250	148	82			
			Nordik 500 PSS, Nordik 550						

POLARIS

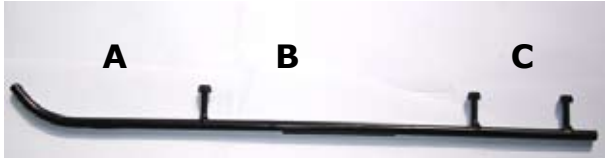
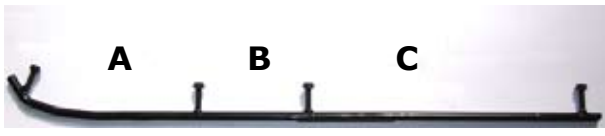
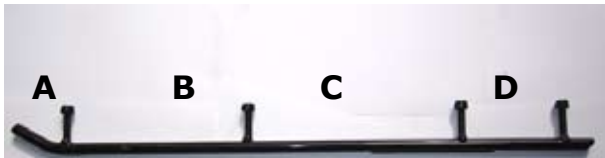
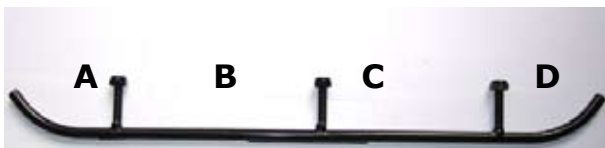
Styrstål

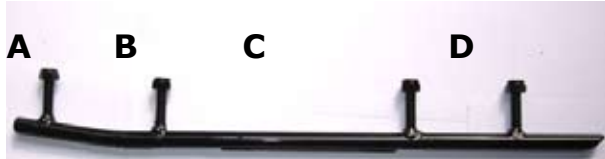
Järn	Racing	Coromant	L=Längd	A	B	C	D	E	
MM202	MM348	MM148	722	180	160	178	178		
			Plast skida 2007- Ersätter originalen MM348 racing styrstål						
MM270		MM149	680	310	178	178			
			Plast skida 1997- Indy RMK 700, Indy XC 400, Indy XCR 600 1997- Indy Storm, Indy Ultra 1997-						
MM206		MM159	673	317	178	178			
			Alla modeller/All mod. 1988-98 Alla med stålskida/ 1998-99 Indy Sport 1987						
MM209		MM177	813	317	178	255			
			Indy 400, 600, Trail, Longtrack, Sprint SS, Star, Startrack 1986-87						
MM208			813	405	408				
			Alla modeller 1971-82 Indy 600, 400, Trail, Longtrack, Sport, SS, Star, LT 1983-85						
	MM398								
			Polaris Gripper skida						
<h2>OCKELBO</h2>									
MM207		MM160	800	395	405				
			Kaikki mallit/All modeller -1986 Ockelbo						
MM228		MM162	450		270				
			Kaikki mallit/All modeller 1987- Ockelbo						
<h2>YAMAHA</h2>									
MM219			578	57	184	311			
			BR 250 1982-94 ET 250, 300, 340 1977-84 SR 540 1980-84 SRX 440 1976-80						

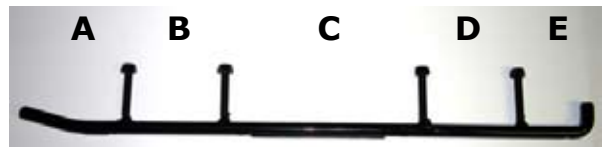
Järn	Racing	Coromant	L=Längd	A	B	C	D	E	
MM217		MM138	621	60	174	268			
			ET 340 1985-88						
MM224		MM164	635	216	292	101			
			Exiter 570 1987-90						
			SR 540, V-MAX 540 1987-91						
MM280		MM137	768		140	360			
			BR 250 T, TS 1984-98						
			ET 340 T, TR 1981-88						
			ET 400 T, TR 1989-91						
			EX 340, 440 1977-81						
MM232		MM166	663	57	183	210	101		
			CS 340 1990-99, Exiter II 570, SX 1991-93						
			Phazer II, E, ST 1984-99, SR 540 1985-86						
			V-Max 540 1983-86, Viking II 540 1988-92						
			XLV 540 1985-91						
MM235		MM175	604		181	210			
			ET 410 TR 1992-99						
			Viking II 540 E 1993-99						
			Venture 480 1991-99						
MM251		MM194	608	159	90	185	90		
			V-Max-4 1992-94						
			Venture 500,600,700 1995-96						
			V-Max 500, 600, 700 1994-96						
			V-Max 800 1995-97						
MM281		MM136	419		82	176	59	62	
			V-max 500, 600, 700 1997-99						
			Venture 500,600,700 1997-99						
MM282		MM135	475		124	160	118		
			SRX 600, 700 1998-						
MM239	MM339	MM139	530	100	90	180	90	70	
			RX, RX-1 2002-						

Powerbloc 80



Servicefri variator till stora vätskekylda maskiner. Den är mycket driftsäker och innehåller inga slitande delar. Man kan montera original startkrans. Variatorn levereras färdigkalibrerat. Har testats av en finsk snöskotermagasin med jätte fin resultat. Kan rekommenderas för alla.

Alla kalibreringar hittar du på våran hemsida:

www.teolehtimaki.fi/varaosaluettelot

Hemsidan uppdateras kontinuerligt!

Skidoo & Lynx modeller

Rotax 699 3-cyl.

Rotax 693 2-cyl

Rotax 670 RAVE

Rotax 594 HO

Rotax 593 RAVE

Rotax 494 RAVE

Rotax 593 HO SDI

Rotax 493 RAVE

Rotax 453 RAVE

Rotax 4-tec V-810

Artikelnummer:

15-81 Rotax modeller, stor kona 2005-

15-82 Rotax modeller, stor kona, -2004

alla med dämpare

Yamaha modeller

Yamaha 750 743 cc 92-94

Yamaha 700 698 cc 96-02

Yamaha 700 696 cc 97-01

Yamaha 600 598 cc 94-99

Yamaha 600 593 cc 99-02

Yamaha 500 494 cc 94-96

Yamaha 500 494 cc 97-01

Alla 4-takt motorer

4-takt 998 cc RX1 2003-

4-t. 1049 cc. 3-cyl. 130 hp

4-takt. 973 cc. 3-cyl. 120 hp

4-t. 499 cc. 2-cyl. 80 hp

Artikelnummer:

15-83 Yamaha modeller, normal kona

alla med dämpare

Polaris

700cc SDI / 700 HO

599cc HO SDI

593cc

599cc SDI

544cc NiCaSil

Också alla andra 488-700 cc

750cc DOHC 4-stroke

750cc EFI 4-stroke

Artikelnummer:

**15-84 Polaris modeller, lång kona, passar till Fuji.
Man kan montera original startkrans
alla med dämpare**

Polaris konor:

vänster, Fuji motor, ca. 28 mm lång
höger, USA motor, ca .33 mm lång

Variator 15-84 passar till alla Polaris modeller, också till Fuji. Konans vinkel är likadan men längre

OBS!! Variatorer som är färdig bestyckad till Fuji passar inte till USA motorer.



Arctic Cat

698 3D 2-cyl. 140 hp 31 mm

599 3D 2-cyl. 114 hp 31 mm

658 cdi 3-cyl. 110 hp 4-takt, 31 mm

594 APV 3-cyl. 120 hp

700 2-cyl. 115 hp

599 APV 2-cyl. 110 hp

580 2-cyl. 96 hp

565 2-cyl. 70 hp

497 APV 2-cyl. 97 hp

499 3D 2-cyl. 105 hp

499 3D 2-cyl. 80 hp

660 CDI 3-cyl. 53 hp 4-takt

698 EFI 3-cyl. 45 hp 4-takt

under 700 cc motorer, kan monteras

Artikelnummer:

15-85 Arctic Cat modeller, gammal kona, generell

15-86 Arctic Cat, Stor kona fr.o.m 2003

alla med dämpare

P50 Variator

Numret är blått



Alla kalibreringar hittar du på våran hemsida:

www.teolehtimaki.fi/varaosaluettelot

Hemsidan uppdateras kontinuerligt!

Nummer	S4B	P50 nummer	CVTech	PTO	rem	x	nummer
15-01	6513B	0403-0001		3,65	31,2		15-02
15-02	5913B	0403-0002		2,50	31,7		15-02
15-03		0403-0003	15-0147C	8,77	34,8	8	15-03
15-04		0403-0004	15-0148C	8,77	34,8	8	15-04
15-05	0513B	0403-0005		11,5	33,3	6	15-05
15-06	8113B	0403-0006	15-0149C	6	34,9		15-06
15-07	5413B	0403-0007		7,5	34,9		15-06
15-09	9513B	0403-0009		11,5	34,9	6	15-09
15-10	9713B	0403-0010		5	33,3		15-10
15-11	9213B	0403-0011	15-0151C	1,5	34,9		15-11
15-18	9113B	0403-0018	fläns	4,99	34,9		15-18
15-19	9613B	0403-0019		8,58	34,9	6	15-19
15-20		0403-0020		8,77	34,8	8	15-03
15-21	9313B	0403-0021	fläns	0,06	34,9		15-21
15-22	3113B	0403-0022	fläns	0,06	32,7		15-22

X = startkrans skruv, 6 mm eller 8 mm



19-100



19-120



19-170 skruv
19-171 polaris skruv
19-140 låsbricka
17-112 mutter
18-160 bricka



19-050



16-08



17-040 Kåpa



19-030



16-07

P50 fjädrar

Nummer	CVTech	N min /	N max /	längd	A. Dia	Hox.
		72 mm	45 mm	mm	mm	
15-52	0151-0002	618 / 637	1050 / 1115	110 / 108	5,26 / 5,50	+ 1
15-51	0151-0003	730 / 730	987 / 1056	158 / 132	4,88 / 5,50	+ 1
15-55	0151-0004	728 / 708	1110 / 1056	134 / 127	5,26 / 5,50	
15-53	0151-0006	500 / 499	1070 / 1142	095 / 93	5,71 / 6,00	
15-54	0451-1118	500 / 501	700 / 832	148 / 114	4,50 / 5,50	+ 1
15-55	0451-1129	700 / 708	1100 / 1056	123 / 127	5,26 / 5,50	
15-56	0451-1137	595 / 604	852 / 929	135 / 122	4,88 / 5,50	+ 1

Blåa fjäderns fjäderstandard är något större på maximal varvtalet än CVTech fjäderns. Kalibrering kan ändras genom att lägga till en pricka för varje viktkloss. Kom i håg: en bricka motsvarar ungefär 100 varv /min. Om koppling varvantalet avsevärt skiljer för det, vad man har angett för motorn, granska alltid sekundärvariatorens fjäderns justering samt linjering av variatoren. Motorn är exakt så bra som kalibrering av variatoren är.

ALT fjädrar

Nummer	CVTech	längd m.fl	min. kg	max. kg
19-12	X-5243212	70	11	171
19-02	X-5243300	76	43	182
19-01	X-5243302	79	53	192
19-03	X-5243304	83	69	209
19-04	X-5243306	86	85	211
19-05	X-5243308	89	94	213
19-06	X-5243310	92	104	216
19-07	X-5218212	70	7	114
19-08	X-5218214	73	19	121
16-20	X-5218300	76	30	127
19-09	X-5218302	79	39	132
19-11	X-5218312	95	77	152
19-13	X-5218304		39	120

P80 fjädrar

Nummer	N min/ 72 mm	N max / 45 mm	Längd / mm	A dia. / mm
15-91	900	1300	138,0	5,50
15-92	900	1600	109,0	6,00
15-93	810	1150	143,0	5,50
15-94	742	1612	95,0	6,00



**Utdragare för modeller:
P50, P80, TRA
Produkt nr: 18-212**

ALT-Variator



15-1213A



15-0513A



15-2913A



15-3113A



15-1713A

Arctic Cat	års modell	prod.	fjäder	prickor	vikt/gr
alla modeller	1970-80	1213	fråga	fråga	
Jag 4000	1981	1213	3	10	
Pantera 5000	1977-81	1213	3	12	
Panther 4000	1977-81	1213	3	9	
El Tigre 5000	1978-80	1213	3	12	
Trail Cat 4000	1980-81	1213	3	10	
Ski-Doo					
Alpine640	1969-75	0913	3		150
Alpine640	1975-82	0613	3		150
Citation 4500/SS	1980-83	0513	1	9	
Citation LS/E	1985-91	3913	1	12	
Elan 250/247cc	1971-96	1013	1	12	
Elan 248-294 cc	1973-79	1013	1	4	
Elite 464 cc	1975-79	0513	1	12	
Everest TNT	1975-79	0513	1	4	
Everest 444/464	1978-83	0513	1	12	
Everest 500	1980-83	0513	1	9	
Olympic mod	1969-75	1013	fråga	fråga	fråga
Skandic 277	1983	3913	2	6	
Scandic 377 / R	1982-87	0513	1	9	
Tundra LT / LTS	1985-92	3913	1	12	
Skidoo modeller	1965-80	fråga	fråga	fråga	fråga
Polaris					
Polaris modeller	1970-80	2815	fråga	fråga	fråga
Star, L/T	1983-87	2815	1	4	
Yamaha					
BR 250	1982-84	2913	1	13	
BR 250 TS, T, LT	1984-01	3113	1	12	
ET 250	1977-81	1713	1	4	
ET 300	1979-84	2913	1	4	
ET 340E, T, TR	1978-88	2913	1	6	
ET 400T, TR	1989-91	2913	1	11	
EC 340 338 cc	1981-88	2913	1	6	
EC 540 535 cc	1979-82	2913	1	12	
EX 340 338 cc	1976-78	2913	1	6	
EX 440 433 cc	1976-81	2913	1	13	
Phazer 433 cc	1984-89	3113	1	13	
SRV 540	1984-91	3113	1	12	
SRX 440	1976-80	3113	1	13	
SS 440	1980-85	3113	4	13	
STX 340	1976-77	2913	1	6	
STX 440	1976-77	2913	1	13	
XLV 540	1985-90	3113	1	12	
Motoski					
Motoski	1973-80	fråga	fråga	fråga	fråga
Futura 400, E	1977-79	0513	3	8	
Futura 444, LC	1978-79	0513	3	7	
Futura 464, RV	1980-83	0513	3	10	
Futura 500	1980-83	0513	3	10	
Mirage 1.	1980-83	0513	2	10	

ALT-Variator



15-3913A



16-11



16-06



16-09



16-08



16-07



16-02



16-16



17-200

Lynx	års modell	prod.	fjäder	prickor	vikt/gr
L 320 295 cc	197?-80	1213A	1	9	
L 520 295 cc	197?-83	1213A	1		60
L 330 340 cc	197?-80	1213A	1	8	
L 535 440 cc	197?-79	1213A	1		60
L 635 440 cc	197?-79	1213A	1		90
GLX 503 cc	1981-82	1213A	1		60
GLX / 5900	1984-93	0513A	1		60
L 535 503 cc	1981-83	1213A	1		60
L 535 503 cc	1984-87	0513A	1		60
L 635 / XL	1981-83	1213A	1		90
GL 3300 377 cc	1982	0513A	2	12	
GL 3900 377 cc	1982-91	0513A	2	12	
L 650 503 cc	1982-92	0513A	1		90
L 250, S 253 cc	1985-91	0513A	2	6	
GL 3300 S 503 c	1984-89	0513A	1	7	
GL 3300 377 cc	1989-90	0513A	1	12	
Ockelbo					
Oc 300	1978-80	3113A	2	14	
Oc 600-1	1978-80	3113A	2	14	
Oc 600-2	1979-81	0513A	2		60
Oc 8000	1980-88	0513A	2		90
Oc 6000	1980-88	0513A	2		60
Oc Poro	1983-85	0513A	2	6	
Oc 4000	1982-83	0513A	2	7	
Oc 5000	1983-88	0513A	2		60
Oc 3500	1986-88	0513A	2	6	
Oc 4500	1986-88	0513A	2		60
Fighter	1988	0513A	2	10	
Trapper	Nordik				
Trapper 5000	1984-	0513A	1	10	
Trapper 6000	1984-	0513A	1		90
Nordik 300, R	1988-	3913A	1	10	
Aktiv					
Aktiv modeller	1976-82	1213A	fråga	fråga	fråga
Aktiv modeller	1983-	0513A	fråga	fråga	fråga
Terri 30					
Terri	1975-	0513A	5		

Fjäder

- 1= 19-01
- 2= 19-02
- 3= 19-03
- 4= 19-04
- 5= 19-05

Variator

- 0513A= 15-0513A
- 0613A= 15-0613A
- 0913A= 15-0913A
- 1013A= 15-1013A
- 1713A= 15-1713A
- 2913A= 15-2913A
- 3113A= 15-3113A
- 3913A= 15-3913A
- 5013A= 15-5013A Nyhet



fjäder

S4B-variator



15-0513B
15-3113B
15-6513B
15-9513B
15-9713B



18-130



18-030



18-100



17-050



17-051



18-060
18-090



18-120



17-090



16-07



16-08

Delar till sekundär



14-06
glidklck



14-10
shim



längd 39 mm
hål 38 mm
ytter. 44,5 mm

14-08
glidlager



14-05
kam 14- modeller

Ski-Doo	års modell	S4B	CVtech	fjäder
SS 25	1984	0513B	15-05	fråga
Safari 377	1984-88	0513B	15-05	fråga
Safari L, LE	1990-92	0513B	15-05	fråga
Scout, Saga	1989-92	0513B	15-05	fråga
Tundra 2, LT	1993-97	9713B		fråga
Polaris				
Lite GT,Deluxe	1991-98	6513B	15-02	fråga
Sport GT	1991-92	6513B	15-02	fråga
Starlite, GT	1991-93	6513B	15-02	fråga
Sport touring	1993-96	6513B	15-02	fråga
Yamaha				
SR540	1981-87	3113B		fråga
Viking 540	1988-92	3113B		fråga
Exciter 570	1987-90	3113B		fråga
Viking 2 540 cc	1992-93	3113B		fråga
Lynx				
GLS 3300	1987-89	0513B	15-05	fråga
GLS 3500	1990-91	0513B	15-05	fråga
GLS 3600	1990-91	0513B	15-05	fråga
GLS 3800	1990-91	0513B	15-05	fråga
L 5900 503 cc	1983-93	0513B	15-05	fråga
L Forest Fox	1993-99	9513B		fråga

Sekundärvariator

14-00 KW-8-25-270 MVLТ

-dia 25 mm axel

-dia 270 mm

m.fl. Ockelbo. Lynx, Trapper Max 1049 hihna

14-01 KW-22,2-250 NK

-dia 22,2 mm axel, kilspår 5 mm

-dia 250 mm

m.fl. Terri 30

14-03 5100-0172

-dia 22,2 mm axel

-6mm kilspår

-dia 250 mm



Lynx " plåt sekundär "

Instruktioner

När du har monterat i en ny variator eller reparerat den gamla, kolla alltid fjädern i sekundärvariatorn. Väldigt ofta är den för svag och fungerar inte som den ska. Den växlar för tidigt och motorn orkar inte. Därför lönar det sig att spänna den gamla fjädern eller montera dit en ny. Du bör också alltid rengöra delarna.

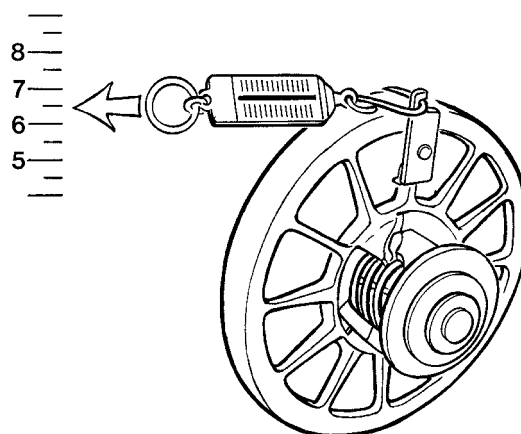

Linjering

Kolla med ett 12 mm tjockt järn eller en rak stång för linjering av variatorerna. Om det inte finns någon vridstopp eller begränsare i din skoter, som kan hindra motorn att vrida sig under drift, så måste måttet **Y** vara ca. 1,0-1,5 mm större än måttet **X**. Notera också att ny CV Tech, IBC är mindre i diameter och därför är manualens **Z** mått ej rätt.

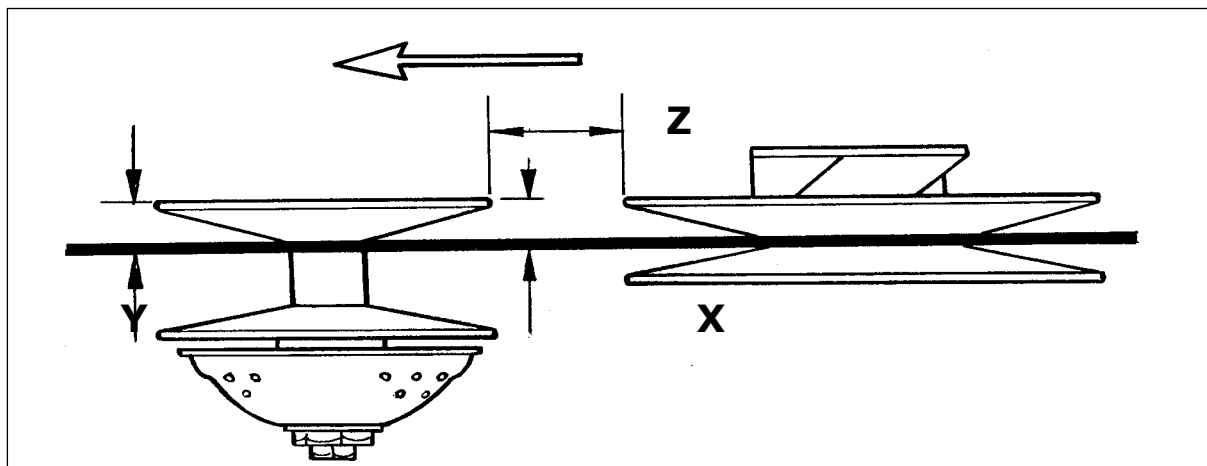

Arctic Cat Ramlager

2-CYL F/C	MGT	CENTER	PTO
340 F/C inj.	DG2555	DG2555	83519 x 83519
440 F/C 1980-97	83519	83519 x 83519-D	83519 x 83519
440 F/C 1988-00	83519	83519 x 83519-D	83519 x 83519
500 F/C	83519 x 83519	83519 x 83519-D	83519 x 83519
570 F/C	6306YR13LT2	6306YR13LT2 x 6306YR13NSL71	OEM
2-CYL L/C			
440 L/C	83519 x 83519	83519 x 83519-D	35NQ5523
440 L/C 1987-89	83519 x 83519	83A073A x 83A073B	83A072-9 x 2
440 L/C ZR-1995	83A073-9	83A073A x 83A073B	40NQ 6430
440 L/C ZR 1996-00	83A073-9	83A073A x 83A073B	40NQ 6430
500-600 ZR T-CRANK	83A073-9	83A073A x 83A073B	40NQ 6430
F-5 04	OEM	83B551A 30mm x 2	40NQ 6430 SP
530 L/C	83519 x 83519	83A073A x 83A073B	83A072-9 x 2
550 L/C 1991-92	83A073-9	83A073A x 83A073B	40NQ 6430
550 L/C 1993-99	83A073-9	83A073A x 83A073B	40NQ 6430
580 L/C 1993-99	83A073-9	83A073A x 83A073B	40NQ 6430
600 ZR 2000-01	306/1DYR1W10MGT	83B551A 30mm x 2	40NQ 6430
650 L/C CARB.	83B551A 35mm	83B551A 35mm x 2	40NQ 6430
700 L/C EFI 1993	83B551A 35mm	83B551A 35mm x 2	40NQ 6430
700 L/C 1994-97	83B551A 35mm	83B551A 35mm x 2	40NQ 6430
F6-F7 2003-05	OEM	83B551A 35mm x 2	40NQ 6430 SP
800-900 ZR 00-03	306/1DYR1W10	6307R/1DYR1NSLT x 2	3208/1DW11
3-CYL L/C			
600 L/C ZRT 600 L/C ZRT 00-01	83A073 A	6207R9-83A073B 6207R9-83A073A	40NQ 6430
900 L/C 1993-00 1000 L/C 1998-00	6306 / 4DYRILT	6209 / DYRILT x 3 6209 / 1DYR1NSLT	6209/1DYRILT x 2
800-900-1000 93-			
2000 BAL SHAFT	6205 C4	6205 C4 x 2	6205 C4

Part number Dimensions

35-35BG06S9	35 X 62 X 23,8
35-5206 S9	30 X 62 X 23,8
35-6007 C4	35 X 62 X 14
35-6007 PC4	35 X 62 X 14
35-6205 C4	25 X 52 X 15
35-6205 NRC4	25 X 52 X 15
35-6206 C4	30 X 62 X 16
35-6206 PC4	30 X 62 X 16
35-6206 NRC4	30 X 62 X 16
35-6206 GPC4	30 X 62 X 16
35-6206 GSPC4	30 X 62 X 18/19

35-6207 C4	35 X 72 X 17
35-6207 PC4	35 X 72 X 17
35-6207 R9	35 X 72 X 17
35-6207 NRC4	35 X 72 X 17
35-6207 GPC4	35 X 72 X 17
35-6207 GSPC4	35 X 72 X 17/18
35-6207 9BA-9T2C4	35 X 72 X 24
35-6208 PC4	40 X 80 X 18
35-6208 GSPC4	40 X 80 X 21
35-6209 1DYRILT	45 X 90 X 19
35-6209 1DRINSLT	45 X 90 X 18

Polaris ramlager

1-CYL F/C	MGT	CENTER	PTO
250 F/C 1985-95	6206 C4		6206 C4 x 2
2-CYL F/C			
340 F/C INJECTION	6206 C4	6007 C4 x 2	6206-GPC4 x 6206-C4
440-500 F/C	6206 PC4	6206 PC4 x 2	6206-GPC4 x 6206-PC4
440 XEF-550 F/C 98-00	5206 S9	6206 PC4 x 2	6206-GPC4 x 6206-PC4
2-CYL L/C			
440 L/C SPEC 95-96 moon key	6206 PC4	6206 PC4 x 2	6206-GPC4 x 6206-PC4
440 L/C SPEC. 97 USA	6207 C4	OEM x 2	6207-NRC4 x 6207-C4
440-500-600 L/C 98-02 USA	6207 C4	OEM x 2	6207/9BA9T x 6207-C4
440-500 L/C SEAL PTO 30	6206 PC4	6206 PC4 x 2	6206-GPC4 x 6206-PC4
500 L/C 96-00SEAL PTO 32	6206 PC4	6206 PC4 x 2	62/63-GPC4 x 62/63-PC4
500 L/C 00-02 MGT moon key	5206-371BLT	6206 PC4 x 2	62/63-GPC4 x 62/63-PC4
700 L/C 1997-98	6207 C4 x 2	6207 C4 x 2	6207-NRC4 x 6207-C4
700 L/C 1999-04	6207 C4 x 2	6207 NRC4 x 2	6207/9BA9T x 6207-C4
800 L/C USA 2000-04	6207 C4 x 2	6207 NRC4 x 2	6207/9BA9T x 6207-C4
3- CYL L/C			
580 L/C 92-94 mono block	6206 PC4	6206 PC4 x 4	6206 GPC4 x 6206-PC4
600 L/C 95-99 mono block	5206-S9	6206 PC4 x 4	6206 GPC4 x 6206-PC4
600 L/C 97 oil jet PTO m.b	5206-S9	6206 PC4 x 4	6206 GPC4 x 5206-S9
600 SP-680 L/C 96-98	35BG06-S9	6007-PC4 x 4	6207 GPC4 x 6207-PC4
650 L/C CARB-RXL 85-98	5206-S9	6206-PC4 x 2	6206 GPC4 x 5206-S9
750-800 L/C STORM 93-97	6207-PC4 x 2	6207-PC4 x 4	6307 GP x 6307-PC4
700-800 XCR 99-03	35BG06-S9	6007-PC4 x 4	6207 GPC4 x 6207-PC4

Yamaha ramlager

1-CYL F/C	MGT	CENTER	PTO
250 ET	6206 C4		6306 NRC4
250 BRAVO	6305 H/INDY		6306 NRC4
2-CYL F/C			
300 F/C-340 cc ET	83464-C	83548D-9	
400 cc-410 cc F/C	83464-C	83548D-9 x 83548D-9	
485 cc-500 cc F/C	DG3268-B	DG3268-B x DG3268-B	
535 cc-540 cc F/C	83548D-9	83548D-9 x 83548D-9	
L/C WITH ROLLER	BEARING		
500-570-600cc 87-96	83B207		
500-600 1997-	83B207		

Part number Dimensions

35-62/32 GC4	32 X 62 X 17
35-6303 C3	17 X 43 X 14
35-6305 C4	25 X 62 X 17
35-6305 NRC4	25 X 62 X 17
35-6305 H/IDNY-9	25 X 68 X 17

35-6306 C4	30 X 72 X 19
35-6306 NRC435-	30 X 72 X 19
35-6307R-1DYR1NSLT C4	35 X 83 X 21
35-307/DYR1W10 C4	35 X 83 X 21
35-3208/1DW11 C4	40 X 83 X 30

Rotax = Lynx, Skidoo Ramlager

1-CYL F/C	MGT	CENTER	PTO
247 F/C 1985-96 ELAN	6305 C4		6305 C4
253 F/C 1985-	6206 NRC4		6206 NRC4
277 F/C 1993-	6206 C4		6206 C4
377-447 1980-81 Points	6207-NRC4	6305-NRC4 ✕ 6305-NRC4	6206-NRC4 x 2
2-CYL F/C			
377-447 1982-89 Nippo	6207-NRC4	6305-NRC4 ✕ 6206-NRC4	6206-NRC4 x 2
377-447 1990-96	6207-NRC4	6207-NRC4 x 2	6207-NRC4 x 2
377-447 1997-	6207-NRC4	6207-NRC4 x 2	6207-PC4 x 2
503 1979-81 Points	6207-NRC4	6305-NRC4 ✕ 6305-NRC4	6206-NRC4 x 2
503 1982-89 Nippo	6207-NRC4	6305-NRC4 ✕ 6206-NRC4	6207-NRC4 x 2
503 1990-96	6207-NRC4	6207-NRC4 x 2	6207-NRC4 x 2
503 1997-	6207-NRC4	6207-NRC4 x 2	6207-NRC4 x 2
550 F/C 2003-	6207-NRC4	6207-PC4 ✕ 6207-PC4	6207-GSPC4 ✕ 6207-PC4
640 F/C 1970-82	6306-NRC4	6306-NRC4 ✕ 6306-NRC4	6306-NRC4
2-CYL L/C			
444 L7C 1977-79	6206-NRC4	6305-NRC4 x 2	6206-NRC4 x 2
454 L/C 1995-98	6206-NRC4 x 2	6206-PC4 x 2	6207-PC4 x 2
462 L/C 1984-86 SP-SS	6206-NRC4	6305-NRC4 ✕ 6206-NRC4	6206-NRC4 x 2
464 L/C 1980-83 Nippo	6206-NRC4 x 2	6305-NRC4 ✕ 6206-NRC4	6206-NRC4 x 2
467 L/C 1985-99	6206-NRC4 x 2	6305-NRC4 ✕ 6206-NRC4	6207-NRC4 x 2
494 L/C 96-02 Tcrank	6206-NRC4 x 2	6206-PC4 x 2	6207-PC4 x 2
494 L/C 2003	6206-PC4 ✕ 6206-GSPC4	6206-PC4 x 2	6207-GSP4 ✕ 6207-PC4
532-536-537-582 85-99	6206-NRC4 x 2	6305-NRC4 ✕ 6206-NRC4	6207-NRC4 x 2
600 L/C 1999-02	6206-PC4 x 2	6206-PC4 x 2	6207-PC4 x 2
600 L/C 2003	6207-PC4 ✕ 6207-GSPC4	6206-PC4 x 2	6207-GSP4 ✕ 6207-PC4
600-700 HO-SDI 2004	6207-PC4 ✕ 6207-GSPC4	6207-PC4 x 2	6207-GSP4 ✕ 6207-PC4
643-617 1991-93	6206-NRC4 x 2	6305-NRC4 ✕ 6206-NRC4	6207-NRC4 x 2
670 L/C 1993-94	6206-PC4 x 2	6206-PC4 x 2	6207-NRC4 x 2
670 L/C 95-99 + HO	6207-PC4 x 2	6206-PC4 x 2	6207-PC4 x 2
700 L/C 1999-00	6207-PC4 x 2	6207-PC4 x 2	6208-PC4 X 2
700-800 L/C 2001-02	6207-PC4 ✕ 6207-GSPC4	6207-PC4 x 2	6208-PC4 X 2
800 L/C 2003	6207-PC4 ✕ 6207-GSPC4	6207-PC4 x 2	6208-GSP4 ✕ 6208-PC4
800 L/ HO 2004-05 SDi	6207-PC4 ✕ 6207-GSPC4	6207-PC4 x 2	6208-GSP4 ✕ 6208-PC4
3-CYL L/C			
599 L/C 1995	6208-PC4	6206-PC4 x 4	6208-PC4 x 2
599 L/C 1996-1997	6208-PC4	6206-PC4 x 4	6208-PC4 x 2
599-699 L/C CK3 98-00	6208-PC4	6206-PC4 x 4	6208-PC4 x 2
700 L/C 1997	6208-PC4	6206-PC4 x 4	6208-PC4 x 2
779 L/C 1993-96	6208-PC4	6207-NRC4 x 4	6208-PC4 x 2
800 L/C 1997-01	6208-PC4	6207-PC4 x 4	6208-PC4 x 2

Part number Dimensions

35-6307 PC4	35 X 80 X 21
35-6307 GPC4	35 X 80 X 21
35-83464-C	25 X 62 X 17
35-83519	30 X 65 X 16
35-83519-D	30 X 65 X 16
35-83548D-9	32 X 62 X 16
35-83A072-9	35 X 75 X 17
35-83A073-9	30 X 72 X 19
35-83A073-A	30 X 72 X 16
35-83A073-B	30 X 72 X 16

35-83A209-1	30 X 72 X 19
35-83A726-9	35 X 80 X 21
35-83A779	32 X 78 X 19
35-83B551-A 35MM	35 X 75 X 17
35-83B551-A 30MM	30 X 75 X 17
35-DG2555 C3	25 X 55 X 15
35-DG3268-B	32 X 68 X 16
35-DG3278 JSO	32 X 78 X 16,5
35-40NQ6430W11	40 X 64 X 30

Nållager

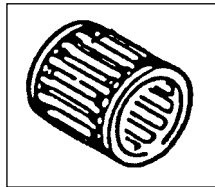

35-500	19 x 23 x 24 (1414)
35-501	16 x 20 x 22 (1404)
35-502	16 x 21 x 20 (1407)
35-503	18 x 23 x 22 (1413)
35-505	18 x 22 x 22 (1410)
35-506	16 x 20 x 24 (1406)
35-508	20 x 24 x 19 (1415)
35-510	18 x 22 x 28 (1411)
35-512	20 x 24 x 24 (1412)

35-513	16 x 20 x 20
35-514	15 x 19 x 20
35-515	16 x 22 x 17
35-517	20 x 24 x 30
35-520	18 x 23 x 21
35-521	20 x 25 x 24
35-522	16 x 20 x 22,5
35-523	20 x 26 x 24

Packboxar

Arctic Cat

09-14600	30x62x10
09-14603	30x65x9/11
09-14605	35x75x9/11
09-14613	25x55x9
09-14616	35x75x8/10
09-14617	35x55x7

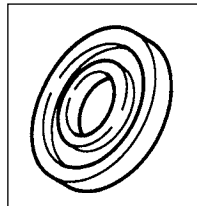

Ski-doo

09-113	30x42x7
09-11301	32x42x7
09-116	25x62x10
09-118	25x41,55x10
09-122	35x62x10
09-125	25x52x7/7,5
09-16002	25x62x63,5x5x6
09-16003	30x62x63,5x5x6
09-165	35x72x7/8
09-167	30x62x7/8
09-168	28x38x7
09-169	30x47x7
09-170	40x80x7

Sachs

09-108	30x47x8
09-114	25x35x7,9

Polaris

09-140	30x62x8
09-14102	30x44x7
09-14103	30x62x8/11
09-14104	30x44x5,7
09-14202	30x62/63,7x7
09-14619	40x64x8

Kohler

09-104	25x42x10/11
09-113	30x42x7

Yamaha

09-131	25x48x8
09-132	30x72x8
09-135	32x78x10x13
09-137	32x78x9,5
09-143	32x48x10
09-14301	35x80x6
09-14302	25/32x78x8
09-14303	25/32x48x8
09-14306	23/35x58x12
09-14311	32x48x9,2
09-14313	32x48x10

Arctic Cat



07-100 01
JAG 87-91, 0109-926

Polaris:



07-100 05
VM 38 SS, 3083171

Rotax



07-100 10
VM 34 rak



07-100 11
VM 34, 570.1262.00



07-100 12
VM 570.1261.00



07-100 13
SKID. VM 30, 32, 34 HD



07-100 20
TUNDRA VM 34



07-100 22
VM34,79-84, 570.1339.00



07-100 23
VM 40, 44, 570.038.200

Förgasargummi



VM 30, 32, 34 HD
07-100 13

Yamaha



07-100 13
VM 30, 32, 34 HD



07-100 13
VM 30, 32, 34 HD

?

Kolla vilken fögasargummi passar på din snaskoter på våran hemsida

[www.teolehtimaki.fi/
varaosaluettelot](http://www.teolehtimaki.fi/varaosaluettelot)

Där hittar du alla andra delar som vi har till din snaskoter

PACKNINGSSATSER

Product	Arctic Cat, års model	packning	Kolv
710-060A	FS CAT 440 FC, 80- , 09-696, 840-80607		09-696
710-063	FS CAT 500 CC, FC, 78-85, 09-693		09-693
710-063B	FC CAT 340 FC, 77- , 09-692, 840-80588		09-692
710-063C	FS CAT 500 EL T. 6000, 80-85, 09-694		09-694
710-063D	FS CAT 530 LC, 86-91, 09-699, 840-80632		09-699
710-063E	FS CAT 500 FC, 86-90, 09-691, 840-8061		09-691
710-179	FS CAT 440 LC 90-00, 09-695, 840-8181		09-695
710-180	FS CAT 700 LC, 91-96, 09-682, 840-8180		09-682
710-189	FS CAT 550+580 91- , 09-681+683+687, -8182		09-681-683
710-193	FS CAT 800 3-CYL. 95-01, 09-602		09-602
710-216	FS CAT 594, 3-CYL. 95-02, 09-601		09-601
710-227	FS CAT ZR500, - 98, 09-605		09-605
710-262	FS CAT 800 2-CYL. 01- , 09-611		09-611
710-266	FS CAT ZL600, 01-02, 09-609		09-609
710-267	FS CAT ZR700, 99-00,		09-
	Rotax Ski-Doo Lynx Trapper Nordik		
710-022X	FS ROTAX 640 74- , 09-762-763		09-762-763
710-023A	FS ROTAX 377, -89, 09-751		09-751
710-023C	FS ROTAX 377, 90-95, 09-751, 841-80238		09-751
710-024	FS ROTAX 250, 71-96, 09-740, ELAN, 8024		09-740
710-025	FS ROTAX 440 (467) 71- , 09-761		09-761
710-026	FS ROTAX 340 76- , 09-747-748		09-747-748
710-119	FS ROTAX 250 TWIN, 73- , 09-745		09-745
710-162A	FS ROTAX 503 -95, 09-741, 841-8162		09-741
710-162B	FS ROTAX 503 -90, 09-741 , 841-8162		09-741
710-162C	FS ROTAX 447 -95, 09-752, 840-8124		09-752
710-163A	FS ROTAX 454 BLIZZ, 79- , 09-760		09-760
710-164	FS ROTAX 253, 85-93, 09-741, 841-8123		09-741
710-165	FS ROTAX 521, 09-741		09-741
710-165C	FS ROTAX 467, -95, 09-761		09-761
710-177	FS ROTAX 536 , 89- , 09-741		09-741
710-178C	FS ROTAX 583 -95, 09-772		09-772
710-194	FS ROTAX 582, -95 , 09-772		09-772
710-195	FS ROTAX 277, 1996- 09-741		09-741
710-196	FS ROTAX 503 FC 95- , 09-741, O-RENGAS		09-741
710-197	FS ROTAX 670, 93-95, 09-773		09-773
710-203	FS ROTAX 467 , 94-96, 09-761		09-761
710-210	FS ROTAX 380, 440, 1996- , 09-751, 09-752, O-		09-751-752
710-211	FS ROTAX 454, 95-97, 09-760		09-760
710-212	FS ROTAX 494 LC, 96-01, 09-780		09-780
710-213	FS ROTAX 599, 3-CYL. 09-774		09-774
710-214	FS ROTAX 599, 3-CYL. 09-774		09-774
710-215	FS ROTAX 670, 95- , 09-773		09-773
710-221	FS ROTAX 800 97-01, 09-782		09-782
710-222	FS ROTAX 700, 97-00, 09-781		09-781
710-235	FS ROTAX 600 , 99- , 09-785		09-785

PACKNINGSSATSER

Product	Rotax Ski-Doo Lynx Trapper Nordik	Kolv
710-255	FS ROTAX 700, 00-02, 09-783	09-783
710-256	FS ROTAX 493, 00-05, 09-784	09-784
710-259	FS ROTAX 593 RAVE, 09-785	09-785
710-261	FS ROTAX 800 , 02-03	
710-277	FS, ROTAX 552, 03---, 09-779	09-779
710-278	FS ROTAX 594 HO 03-05, 09-776	09-776
	Polaris	
710-069	FS POL 244, ALL, 09-700, 840-8069	09-700
710-070	FS POL 250 74-78, 09-702	09-702
710-071	FS POL 250, 76-89, 09-703	09-703
710-073	FS POL 340 77-81, 09-708	09-708
710-075	FS POL 340 73-82, 09-706	09-706
710-078	FS POL 440 75-81, 09-704	09-704
710-079	FS POL 440 75-80, 09-705	09-705
710-109C	FS POL 400 2-CYL. 84-91, 09-707	09-707
710-110	FS POL 600 3-CYL. 84-87, 09-707	09-707
710-110A	FS POL 440 82-99, 09-710	09-710
710-110C	FS POL 488 FC 86-99, 09-712, 840-81108	09-712
710-173	FS POL 340, 86-93, 09-709 JA 94-, 09-717	09-709
710-181A	FS POL 650 88-97, 09-713, 840-8187	09-713
710-185A	FS POL 488 LC, 89-02, 09-711, 840-8188	09-711
710-186	FS POL 440 FC 91-99, 09-710	09-710
710-191	FS POL 580 93-94 , 09-714	09-714
710-204	FS POL. 94-97, 09-716	09-716
710-205	FS POL 600 3-CYL. 95-00, 09-716	09-716
710-206	FS POL 679 3-CYL. 96-97 , 09-718	09-718
710-231	FS POL. XC700, 98-01, 09-721	09-721
710-238	FS POL FC 550, 99- , 09-727	09-727
	Yamaha	
710-027A	FS YAMAHA 250 BRAVO 84- , 09-800	09-800
710-140A	FS YAMAHA 535, 83-91, 09-816	09-816
710-142	FS YAMAHA EX 340 81-88, 09-802	09-802
710-142C	FS YAMAHA 340 , 89- , 09-802	09-802
710-146	FS YAMAHA EX 440 76-81, 09-806	09-806
710-147C	FS YAMAHA SS440 80-83, 09-807	09-807
710-167	FS YAMAHA 535 CC SRV 82-90, 09-808	09-808
710-167A	FS YAMAHA 540,540 SRV 85-90	09-808
710-168	FS YAMAHA PZ 480 84-90, 09-813	09-813
710-168B	FS YAMAHA 485 CC, -07, 09-813	09-813
710-171	FS YAMAHA 570 -90, 09-817	09-817
710-171A	FS YAMAHA 570 CC, 91-, 09-817	09-817
710-182	FS YAMAHA 535 VIKING 92- 07, 09-808	09-808
710-200	FS YAMAHA 494 CC 94-96, 09-825	09-825
710-201	FS YAMAHA 598 CC 94-95, 09-826	09-826
710-239	FS YAMAHA 485 CC, (500) -07 09-813	09-813

Arctic Cat Kolvar Packning Nållager Stefa

Arctic Cat	dia mm	ccm/cm3	packning	nållager	stefa magn	stefa var.
EXT 600 Tr. 97-98 EXT 600 Triple Touring 1998 Powder EXT 600 1997-98 ZRT 600 1995-98						
09-601	66,50	594 3-syl	710-216	35-503	09-14618	09-14619
Pantera 800 1998-01 ZRT 800 1995-01						
09-602	72,00	794 3-syl	710-217	35-523	09-14618	09-14619
ZL 500 EFI 1998-01; ZR 500, ERSI 1998-01; Powder SP 500 EFI 1999-01						
09-679	71,00	497 2-syl		35-523	09-14618	09-14619
EXT 580 MC; EXT 580 EFI MC 1993-97; 580 Powder SP 1995-97; ZR 580 1993-97; Pantera 580 1995-97						
09-681	75,40	580 2-syl	710-189	35-523	09-14618	09-14619
Wildcat 700 MC. EFI 1991-96, ZR 700 1995, ZL 700 2000, ZR 700 1999-00						
09-682	81,00	699 2-syl	710-190	35-523	09-14617	09-14619
EXT special 1991-92; EXT Mountain Cat 1991-92; EXT 550 EFI, EFI Mtn Cat 1993-94 Bear Cat 550WT 2000- Pantera 550 2002-05, Panther 550 2000-01, ZL 550 ESR 2000-03						
09-683 (687)	73,40	550 2-syl	710-189	35-523	09-14618	09-14619
Wildcat 650 1988-90, Mountain Cat 1990						
09-684	78,00	650 2-syl		35-523		
Panther, Puma, Cheetah, Pantera 1971-1975 Lynx II -74Jag 340 -75						
09-685	60,00	339 2-syl		35-525		
Bearcat 550 1995-98; Cheetah 550 1994; Cougar 550 1995-98; EXT 550, EFI 1993-98; Pantera 550 1993-94; Panther 550 1997-98; Prowler 550 1995						
09-687	73,40	550 2-syl	710-189	35-523	09-14618	09-14619
El Tigre 440 Z 1975-77; Kawasaki Intriguer, Intruder, Invader; Drifter 440 1978-81						
09-689	68,00	440 2-syl		35-522	09-14603	09-14603
Cheetah FC, Cougar 1986-90						
09-691	70,00	500 2-syl	710-063E	35-503	09-14603	09-14603
Bearcat 340 1995-01; Cheetah 340 1994; Jag 340 1976-77, 1987-90; Jag 3000 FA, FC 1978-80 Jag Deluxe 1987-90; Jag Mountain Cat 1990-91; Jag 340 DeLuxe 1998-99; Panther 340 1998-01 Trail Cat 3000 FC 1980; Manx, Manx Deluxe 1991-93; Manx Mountain Cat 1992-93; Puma DeLuxe 1994-97						
09-692	60,00	339 2-syl	710-063B	35-502	09-14603	09-14603
Cheetah 5000 1976-78; El Tigre 500 1976; El Tigre 5000 1977-81; Pantera 5000 1976-81; Panther 500 1976 Cougar Spec. Edition 1985; Panther 1986-88; Pantera el. 1980; Manx 2000S 1977-80, El Tigre 6000 LC 1980-85						
09-693	70,00	500 2-syl	710-063	35-503	09-14603	09-14603
El Tigre 6000 LC 1980-85						
09-694	70,00	500 2-syl	710-063C	35-503	09-14603	09-14603
El Tigre 6000 LC 1978-79; El Tigre Cross Country 1979; Pantera LC 1985-92; El Tigre 5000 LC 1987 Jag 440 LC 1987; Panther 440 LC 1996; ZL 440 1997-99; Prowler 1990-94; Cheetah Touring 1991-93; Cougar 1991-94.						
09-695	68,00	440 2-syl	710-063A	35-503	09-14603	09-14603
Bearcat 440 1995-01; Cheetah 440 1994; Panther 4000 FC 1980-81; Trail Cat 4000 FC 1980-81; Jag 4000 FC 1980-81; Jag AFS LT 1991-93; Jag FC 1985-87; Jag 440 DeLuxe 1988-99 Jag 440 Z 1991-96; Panther DeLuxe 440 1984-01; Z 440 ES 1990-01; Super Jag 1991-92						
09-696	65,00	431 2-syl	710-060A	35-502	09-14603	09-14613
Cheetah LC 1986-89; El Tigre 6000 1986-89; El Tigre EXT 1989-91; El Tigre Ext Mountain Cat 1990						
09-699	72,00	529 2-syl	710-063D	35-503	09-14603	09-14605

Kolvringar

MOS 2 ytbehandling

Rotax 503-253

10-741-00
10-741-01
10-741-02
10-741-04

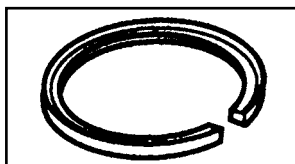

57

Kolvbult

Rotax 377

10-751-00
10-751-01
10-751-02
10-751-04

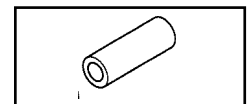

**11-741
11-751**

Skidoo, Rotax

Kolvar Packning Nållager Stefa

Ski-Doo	dia mm	ccm/cm3	tiivistesarja	neulalaakeri	tiiviste .magn	tiiv.kytkin
Spirit 250 1976-78; Elan 250 E 1971-78						
09-740	69,00	247 1-syl		35-505	09-118	09-118
09-740-02	69,50					
09-740-04	70,00					
Spirit 250 1979-83; Elan 250 1979-96						
09-740-02	69,50	250 1-syl		35-505	09-118	09-118
09-740-04	70,00					
Rotax 253, 277, 503,521,536 Lynx, Nordik, Ockelbo, Skidoo, Trapper, Winha, Freestyle, Tundra						
09-741	72,00	253 1-syl		35-505	09-126	09-146
09-741-01	72,25	277 1-syl		35-505	09-168	09-169
09-741-02	72,50	503 2-syl		35-505	09-165	09-167
09-741-04	73,00	521 2-syl		35-505	09-167	09-165
09-741-06	73,50	536 2-syl		35-505	09-167	09-165
Olympic 320, 320E 1969; Olympic 300, S, M, 1971-77						
09-742	76,00	319 1-syl		35-505	09-118	09-118
09-742-02	76,50					
Elan 250 1973-79						
09-745	54,00	247 2-syl	710-119	35-514	09-118	09-118
09-745-02	54,50					
Olympic 335 1969-72; Skandic 1970-73						
09-746	78,00	335 1-syl		35-505	09-118	09-118
09-746-02	78,50					
TNT 340, 1972-76; Olympic 340, E 1975-79; Everest 340, E 1977-79; Futura 340 1975; Nuvik 340, E 76-79						
09-747	59,50 left	339 2-syl		35-505	09-167	09-167
09-747-02	60,00 left					
09-747-04	60,50 vasen					
09-748	59,50 right	339 2-syl		35-505		
09-748-02	60,00 right					
09-748-04	60,50 oikea					
Blizzard 6500 Plus, 7500 Plus, Cross Country 1978-81; Super Sonic 1979-81						
09-750	59,50	339 2-syl		35-505	09-165	09-167
09-750-02	60,00					
Rotax 377 ; Lynx, Nordik, Ockelbo, Skidoo, Trapper, Winha						
09-751	62,00	377 2-syl		35-505	09-165	09-167
09-751-01	62,25					
09-751-02	62,50					
09-751-04	63,00					
09-751-06	63,50		MOS 2 ytbehandling			
Rotax 447; Lynx, Ockelbo, Skidoo, Trapper, Scandic 440 LT 2001-07, MXZ 440 1999-01, TOUR. E 1999-						
09-752	67,50	447 2-syl	710-162C	35-505	09-165	09-167
09-752-01	67,75					
09-752-02	68,00					
09-752-04	68,25					
Everest 440 FC 1974-79; TNT 440 FC 1975-78; Olympic 1977; Futura 440 1975-79; Nuvik 440 1977						
09-758	67,5 left	436,6 2-syl		35-505	09-122	09-116
09-758-02	68,00					
09-759	67,5 right	436,6 2-syl		35-505	09-167	09-167
09-759-02	68,00					

Ski-Doo	dia mm	ccm/cm3	packning	nållager	stefa .magn	stefa var.
Blizzard 9500 1979-82; Ultra Sonic 1980-82						
09-760	67,50	436,6 2-syl	710-163A	35-505	09-167	09-167
09-760-01	67,75					
09-760-02	68,00					
09-760-04	68,50					
Rotax 444, 467; Elite 450 LC 1978-79; Everest 444 LC 1978-79; Everest 464 LC 1980-83; SS-25 1984						
Grand Tour. 470 1995; Formula SS 1985; Formula St 1994; Formula SP 1985-86; Formula MX, LT, XTC 1985-95 Formula MXZ 1993-94; Safari GLX, LC, LCE 1990-92; Summit 470 1994-95						
09-761	69,50	436,6 2-syl	710-025, -71-	35-505	09-167	09-167
09-761-01	69,75					
09-761-02	70,00	462,8 2-syl	710-165C, -95	35-505	09-167	09-165
09-761-04	70,50		MOS 2 ytbehandling			
Alpine 640 1969-82; Nordic 640 1970-74; TNT 640 1971-72; Valmont 1971-72						
09-762	76,00 left	635 2-syl		35-505	09-103	09-103
09-762-02	76,50					
09-762-04	77,00					
09-763	76,00 right	635 2-syl		35-505		
09-763-02	76,50					
09-763-04	77,00					
Rotax 583, 621; F Mach 1, XTC 1989-92; F Plus, E, XTC, X 1992-93; F Plus EFI 1993-94;						
F GT 580 1993-96; F STX 1994-96; Summit 1994-96; F Z 1994-96						
09-772	76,00	583 2-syl	710-178C, 583	35-505	09-167	09-165
09-772-01	76,25					
09-772-02	76,50	617 2-syl	710-194, 582			
09-772-03	76,75					
09-772-04	77,00					
Rotax 670; Mach 1 X 1993; Mach 1 1993-96; MXZ 670 1996-99; GT SE 1994-96;						
F SS 670 1995-96; Summit 670						
09-773	78,00	669 2-syl	710-215	35-524	09-167	09-165
09-773-01	78,25					
09-773-02	78,50					
09-773-04	79,00		MOS 2 ytbehandling			
Formula 3 600 1995-97						
09-774	64,50	600 3-syl		35-503		09-165
Rotax 550 fan 2003-						
09-779	75,86	550 2-syl	710-277	kehä	09-165	09-165
09-779-01	76,11					
09-779-02	76,36					
09-779-04	76,86					
Rotax 500, 780; F Z 500 1999; F 500, DLX, SLS 1996-00; GT 500 1996-99; Mach Z 780 1993-97;						
MXZ 500 98-Scandic WT LC 1999-00; Summit 500 1996-99; Touring 500 LC 2000						
09-780	69,50	500 2-syl	710-212	35-505		09-165
09-780-02	70,00	779 3-syl				
Rotax 700; F 3 700 1998-00; GT 700 1998-00; GT SE 1997-98; Mach 1 700 1997-00						
09-781	69,80	699 3-syl	710-222	35-503		09-170
Mach Z 800 1997-99; F 3 800 1999, Mach Z 800 1997-2002,						
09-782	70,50	796 3-syl	710-221	35-503	09-170	09-170
Formula 700, Legend 700, MXZ 700 Summit 700 2000-2002						
09-783	78,00	700 2-syl	710-255			

Skidoo, Rotax

Kolvar Packning Nållager Stefa

Formula600 1999-01, Formula 600 GS 2001, Formula Z 1999-00, GT 600 1999-01, MXZ 600 1999-02

Scandik 600 WT L/C 2001-02, Summit 600 1999-01, GT 600 GS, SE, Sport, Legend 600 2002

MXZ 600 Adr., Renegade, Sport, Trail, RER Sport, Sport 2002, Lynx 600 L/C modeller

09-785	76,00	597 2-syl	710-259			
09-785-02	76,50					

Polaris Kolvar Packning Nållager Stefa

Polaris	dia mm	ccm/cm3	packning	nållager	stefa .magn	stefa.var
---------	--------	---------	----------	----------	-------------	-----------

Charger, Mustang 488 1971; Voyager 488 1971; Colt 250 1972-78; Custom 2 1971; TC 250 1974-75;

Electra 250 1975-77; Gemini 244 1979-83; Star 1983-90; Startrak 1987-90; Starlite Gt 1991-95

09-700	72,00	488 2-syl	710-069	35-520	09-14102	09-14102
09-700-02	72,50	244 1-syl				
09-700-04	73,00					

Colt 250 1976-78

09-702	53,50	250 1-syl	710-070	35-520	09-14103	09-14102
---------------	-------	------------------	---------	--------	----------	----------

Starfire 250 1976; TX 250 1976-79

09-703	53,40	250 1-syl		35-520	09-14103	09-14102
---------------	-------	------------------	--	--------	----------	----------

TX 440 1973; Electra 440 1974-77; Cobra 440 1978-79; Galaxy 440 1980-81; Cutlass 440, E 1981-82;

TX-C 440C 1981; Long Track 1983-86; Sport, Super Sport SS 1983

09-704	67,72	432 2-syl	710-078	35-520		
09-704-02	68,22				09-14102	09-14102

TX 440 1976-80

09-705	67,75	440 2-syl	710-079	35-520	09-140	09-140
---------------	-------	------------------	---------	--------	--------	--------

Starfire 340. 1976, TX 340 F/A 1973-82

09-706-01	62,00	336 2-syl	710-075	35-513		
------------------	-------	------------------	----------------	--------	--	--

Indy 400 1984-1991; Indy 600 1984-87

09-707	65,00	398 2-syl	710-109C	35-503	09-14102	09-14102
09-707-01	65,25					
09-707-02	65,50	597 3-syl	710-110			
09-707-04	66,00					

Colt SS 340 1977; Cobra 340 1978-79; SS 340 1979; Apollo, Galaxy, Cutlass 340 1979-1981

09-708	61,78	333 2-syl	710-073	35-513	09-14102	09-14102
09-708-02	62,28					

Sprint ES 1986-90; Indy Sport, GT 1987-90; Indy Lite, GT, Starlite 1991-93

09-709	62,25	339 2-syl	710-173	35-525	09-14102	09-14102
09-709-01	62,50					
09-709-02	62,75					
09-709-04	63,25					

TXC 440 FC 1982; Indy Trail 1983-1986; Long Track 1984-90; Indy Sport 1991-98; Sport GT 1991-93

Sport Touring 1995-98; Super Sport 1995-96; Transport 1996-98

09-710	67,75	440 2-syl	710-186	35-503	09-14102	09-14102
09-710-02	68,25					
09-710-04	68,75					

Indy 500 LC, Classic 1989-00; Indy 500, SKS, SP, 1990-98; Indy 500 EFI 1992-98

Indy Classic Touring 1993-94; Indy Widetrack 1997-98

09-711	72,00	488 2-syl	710-185A	35-503	09-14102	09-14102
09-711-01	72,25					
09-711-02	72,50					
09-711-04	73,00		MOS 2 ytbehandling			
09-711-06	73,50		60			

Polaris

Kolvar Packning Nällager Stefa

Polaris	dia mm	ccm/cm3	packning	nällager	stefa .magn	stefa var.
Polaris						
Polaris	dia mm	ccm/cm3	tiivistesarja	neulalaakeri	tiiviste .magn	tiiv.kytkin
Indy Trail FC 1986; Indy Tr. DeLuxe 1988-92; Super Sport 1997-98; Supertrac 1991-93; Indy Trail, Touring 1994-99						
09-712	72,00	488 2-syl	710-110C	35-503	09-14202	09-14202
09-712-01	72,25					
09-712-02	72,50					
09-712-04	73,00					
Indy 650, SKS 1988-93; Indy 650, RXL, SKS, 1990-97						
09-713	67,75	648 3-syl	710-181A	35-503	09-14202	09-14104
09-713-01	68,00					
09-713-02	68,25					
09-713-04	68,75					
Indy 580 XLT, SKS, XLT SP 1993-94						
09-714	64,00	579 3-syl	710-191	35-525	09-14202	09-14202
09-714-01	64,25					
09-714-02	64,50					
09-714-04	65,00					
Indy 440 XC 1992; Indy 440 XCR 1993-94; Indy Trail DeLuxe 1993						
09-715	67,72	440 2-syl		35-503	09-14202	09-14202
09-715-01	67,97					
09-715-02	68,22					
Indy XLT 600 1995-98; XLT SP 1997-98; Indy XCR 600 1995-97; XC 600 1997						
09-716	65,00	597 3-syl	710-205, 95-00	35-525	09-14202	09-14202
09-716-01	65,25					
09-716-02	65,50		710-204, 94-97			
Indy Lite, DeLuxe; Indy Lite Gt 1994-98; Indy Lite Touring 1998						
09-717	62,30	340 2-syl		35-525	09-14202	09-14202
09-717-01	62,55		MOS 2 ytbehandling			
09-717-02	62,80					
09-717-04	65,50					
Indy Ultra SP, Ultra SPX, SE, Ultra Touring 1996-97						
09-718	66,50	679 3-syl	710-206	35-503		
Indy Storm 800 1994-98						
09-719	72,00	794 3-syl		35-503		
RMK 500, SKS 2000-02, 500 XC1999-02, Indy500 99, Indy 500 XC SP 1999-07, Indy 500 2001						
09-720	70,50	500 2-syl				
09-720-02	71,00					
Indy 550 Classic, Sport Touring, Supersport 1999-2006, Pro X Fan,						
09-727	73,0	550 2-syl	710-238	35-503		
09-727-01	73,25					
09-727-02	73.50					
09-727-04	74,00					
Indy 600 Classic, Touring 2001, Indy 600 Touring 2000, 600 XC SP, Edge 2000, 600 XC SP 2001						
09-728	77,25	600 2-syl				
Indy 800 XC SP 2001-05, 800 SKS 2003, 800 Classic 2004, 800 LE 2001, 800 Pro X 2003-04, 800 Edge 04						
09-730	85,00	800 2-syl		35-526		

Yamaha Kolvar Packning Nällager Stefa

YAMAHA	dia mm	ccm/cm3	packning	nällager	stefa .magn	stefa var.
Br 250 1982-94 Br 250T, TS 1985-00; BR 250 TS 1984-97						
09-800	70,00	246 1-syl	710-027	35-505	09-131	09-132
09-800-01	70,25					
09-800-02	70,50					
ET 250 1977-81						
09-801	72,96	246 1-syl	710-138	35-522	09-131	09-132
09-801-01	73,21					
09-801-02	73,46					
09-801-04	73,96					
EC 340 1982-88 ET 340 1978-88 CS 340 1989-00						
09-802	60,00	337 2-syl	710-142	35-522	09-131	09-132
09-802-01	60,25					
09-802-02	60,50					
09-802-04	61,00					
GP 338 1973 SL 338 1974 GS 338, 340 1976-1979						
09-803	60,00	338 2-syl		35-505	09-135	09-143
09-803-02	60,50					
09-803-04	61,00					
EX 340 1976-78 STX 340 1976-1977						
09-804	60,00	338 2-syl	710-141	35-505	09-137	09-143
09-804-02	60,50					
GP; TL, 433 1975 EX 440 1976-81 GP 440 1976-78 PR 440 1976-77 STX 1976-77						
09-806	68,00	433 2-syl	Katso tiiviste	35-505	09-137	09-143
09-806-01	68,25		kelkkakohtaisesta			
09-806-02	68,75		luettelosta			
09-806-04	69,00					
SS 440 1980-83						
09-807	66,00	440 2-syl	710-147C	35-505	09-137	09-143
09-807-02	66,50					
EC 440 1979-84 SR 540 1980-91 XL 540 1985-90 VK 540 1988-00						
09-808	73,00	535 2-syl				
09-808-01	73,25					
09-808-02	73,50					
09-808-04	74,00					
SL 292 1971-72						
09-810-02	73,50	292 1-syl		35-505		
ET 300 1980-84						
09-811	56,00	294 2-syl	710-138A	09-505	09-135	09-143
09-811-02	56,50					
GP 292 1972-73 SM 292 1973-74						
09-812	73,00	292 1-syl		35-505		
09-812-02	73,50					

Katso tiiviste kelkkakohtaisesta luettelosta. Kyseisen männän kohdalla on aina kyseessä monta vuotta, ja tiiviste saattaa vaihtua jossain mallissa. Lisäksi huomaa, kaikki kelkat eivät välttämättä ole luetteloitu tälle sivulle.

Yamaha Kolvar Packning Nällager Stefa

YAMAHA	dia mm	ccm/cm3	packning	nällager	tiiviste .magn	tiiv.kytkin
YAMAHA	dia mm	ccm/cm3	tiivistesarja	neulalaakeri	tiiviste .magn	tiiv.kytkin
PZ 480 1984-98 480 ST 1991-98 VT 480 1991-97 VT 480 GT 1993-9 VT 480 TF/X 1993-00						
PZ 500 1999-00; PZ 500 ML 2000 PZ Mtn 480 1999 Venture 500 1999-06						
09-813	72,00	485 2-syl	710-168	35-505	09-14303	09-14302
09-813-01	72,25		Katso tiiviste			
09-813-02	72,50		kelkkakohtaisesta			
09-813-04	73,00		luettelosta			
SR 433, GPX 433 1971-75						
09-814	68,00	433 2-syl		35-505	09-137	09-143
09-814-01	68,25					
09-814-02	68,50					
09-814-04	69,00	433 2-syl		35-505		
GPX 338 F/A 1974-75						
09-815	60,00	338 2-syl		35-505	09-137	09-143
09-815-01	60,25					
09-815-02	60,50					
VMX 540 1983-91						
09-816	73,00	535 2-syl	710-140A	35-521		
Exciter 570, 1987-90 Exciter 2, 1991-92						
09-817	73,00	569 2-syl	710-171	35-521	09-14313	09-14301
09-817-02	73,50		710-171A			
09-817-04	74,00		MOS 2 ytbehandling			
SRX 440 1978-1980						
09-818	68,50	439 2-syl	710-147A	35-512	09-137	09-143
09-818-01	68,75					
09-818-02	69,00					
V-Max 500 LE, DX, ST, 1994-96						
09-825	68,00	493 2-syl	710-200	35-521		
V-Max 600, LE, DX, ST, 1994-96						
09-826	74,80	598 2-syl	710-201	35-521		
09-826-02	75,30					

Kohler, Sachs, Kawasaki Kolvar Packning Nällager Stefa

Kohler	dia mm	ccm/cm3	packning	nällager	stefa .magn	tiiv.kytkin
Kohler 340 motor						
09-670	62,00	340 2-syl		35-520	09-104	09-113
09-670-01	62,25					
09-670-02	62,50					
09-670-04	63,00					
Sachs						
Sachs 440						
09-SM127	67,40	436 2-syl			09-116	09-127
Kawasaki						
Kawasaki 440 Kawasaki Intriguer, Intruder, Invader; Drifter 440 1978-81						
09-689	68,00	440 2-syl		35-522	09-14603	09-14603
Invader 340 F/C 1978-80, Inviter 340 F/C 1978, Drifter F/C 1979-81						
09-685	60,00	339 2-syl		35-525		

Vindrutor

Obs: mät alltid rutans höjd längs rutans ytan i mitten !!!

00-110	5 393 062	GL 250 - >88
00-111	524090X	GL 250 S, GL 230 89->91
00-112	526754	GL 360 S 92->95
00-115	539504	Forest Fox 96->98, 01
00-120	522842X	GL 3900, GLX 5900 metalfäste->93
00-121	538284-1	GLX 5900, skruvhål 1995
00-122	523192X	GLS 3300 låg
00-123	538616	GLX 5900, laxfena 1995
00-130	524126X	GL 3300, GL 3900 S, 88->92
00-131	526976	COBRA 1992
00-132	527091	COBRA 1992->93
00-133	538837	COBRA 94->95, ULTRA 94->96
00-140	5393890-1	640
00-141	6500202-2	650 skruvhål 1995
00-142	533084X	650 met. 83->94
00-151	537644	RANGER, LIGHT, GT 93->97
00-161	5241171	RANGER; LIGHT hög
00-171	5241478	G-TYPE, svart 1997-00
00-172	5143618	G-TYPE, G-TOUR, Sport XR , låg
00-173	5143619	G-TYPE, XR 500 F, G-TOUR: högre
00-181	5241686	GLX 5900 96->99, 6900 1997
00-300	Nordik 300	
00-377	Nordik 377 R	
00-500	Nordik 500, 600, 7 fenor	
00-510	Trapper, 5000, 5 fenor	
00-550	Nordik 550	

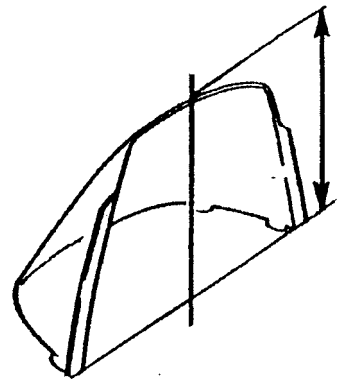

Vindrutor är originala

Gamla modeller, veteraner



37-08



41-40

37-08 Ockelbo gummi fjäder



00-600 Lynx dekaller 1969-75

00-601 Lodjur, vit. 1969-75

00-602 Team Lynx dekal, -80 talet

41-40 Babfjäder Lynx 40, 30, 20

41-535 Hjul boggie Lynx, Winha

12-165 Spegel



Arctic Cat

Bromsbelägg

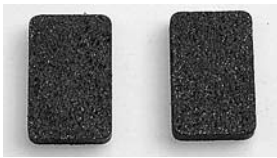

05-15225 par
AC 0109-932

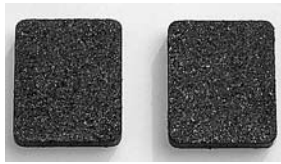

05-15232 par
AC 0115-603



05-15240 par
AC 0702-264

Polaris



05-15241st
AC 0702-229



05-15203 par
Pol 193034/5



05-15214 st
Pol 1930 569

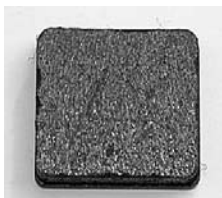

05-15231 st
Pol 1930 588



05-15237 st
Pol 1930 586



05-15243 par
Pol 1930 723

Ski-Doo Lynx

Nordik



05-15212
Sk 860.701.400

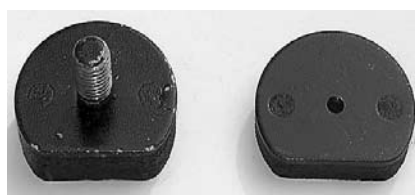

05-15235 par
Skidoo, Lynx, Nordik



05-15247 par
Sk 860.701.700



05-15241 st
Sk 414.933.700
Lynx

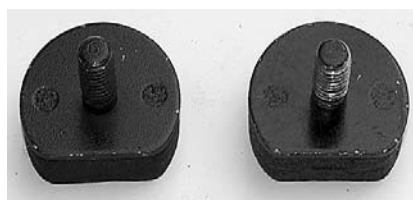

05-15242 par
Sk 860.700.700
Lynx



05-15246 st
Sk 414.990.000
Lynx

Yamaha

Bromsbelägg



05-15224 par



05-15228 st



05-15245 st



05-15249 par

Plåt kedjor (Silent, Hyvo, DID)

Bild	Prod	Plåt	Konstruktion	Stämpel	Tillverkare	Notera
1	45-	11	1-2-1-1-1-1-1-2-1	LB S37 U.S.A	Rexnord	Silent 11
2	46-	13	1-2-1-1-1-1-1-1-1-2-1	LB S37 U.S.A	Rexnord	Silent 13
3	50-	15	1-2-2-2-1-2-2-2-1	LB S37 U.S.A	Rexnord	Silent 15
4	ei	13	1-1-1-1 (x 13)	DID	D.I.D	
5	ei	15	1-1-1-1 (x 15)	DID	D.I.D	
8	ei	15	??	Morse	Borg Warner	Hyvo 7/8
7	52-	13	1-2-1-1-1-1-1-1-1-2-1	Morse	Borg Warner	Hyvo 3/4

Rexnord

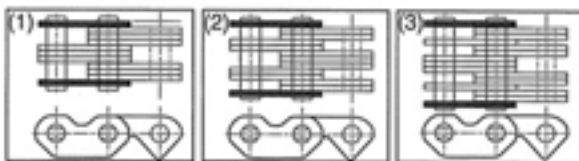

Kuvista näkyy levyjen vanha niputus, mutta näitä nykyisiä voi käyttää, kunhan leima on sama.

On kaikkein yleisin ketjumalli. **Silent**

Borg Warner

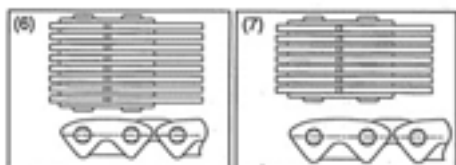

Kuvista näkyy levyjen vanha niputus, mutta näitä nykyisiä voi käyttää, kunhan leima on sama.
Kauppanimi, **Hyvo 3/4**

D.I.D.

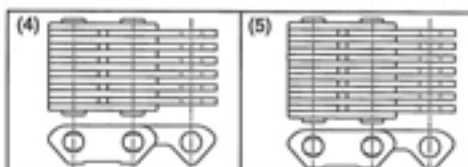

DID ketjua on käyttänyt Yamaha 1990 luvulla.
Harvinainen malli.

Silent kedjor

11 lamel	längd	13 lamel	längd	15 lamel	längd
45-064	64	46-064	64	50-064	64
45-066	66	46-066	66	50-066	66
45-068	68	46-068	68	50-068	68
45-070	70	46-070	70	50-070	70
45-072	72	46-072	72	50-072	72
45-074	74	46-074	74	50-074	74
45-090	90	46-076	76	50-076	76
		46-104	104	50-078	78
		46-106	106		
		46-108	108		



Kugghjul, Skidoo, Lynx

11 bredd	Z	13 bredd	Z	15 bredd	Z
45-016	16	46-016	16		
45-017	17	46-017	17		
45-018	18	46-018	18		
45-019	19	46-019	19	50-019	19
45-020	20	46-020	20	50-020	20
45-021	21	46-021	21	50-021	21
45-022	22	46-022	22	50-022	22
45-023	23	46-023	23	50-023	23
45-024	24	46-024	24	50-024	24
		46-025	25	50-025	25
		46-026	26		



Nedre kugghjul, Skidoo, Lynx

13 bredd	Z	13 bredd	Z	15 bredd	Z	15 bredd	Z
stål		aluminium		stål		aluminium	
55-43	43	56-43	43	58-43	43	60-43	43
55-44	44						
55-45	45	56-45	45	58-45	45	60-45	45

Kugghjul, 7/8"-13 spline

Arctic Cat alla, ej Diamond drive, Polaris till 1996

11-bredd	Z	11-bredd	Z	13-bredd	Z	13-bredd	Z
47-016	16	47-021	21	48-016	16	48-021	21
47-017	17	47-022	22	48-017	17	48-022	22
47-018	18	47-023	23	48-018	18	48-023	23
47-019	19	47-024	24	48-019	19	48-024	24
47-020	20			48-020	20		

3/4" Hyvo ketjut

Original Borg Warner kedja

3/4" bredd	längd		3/4" bredd	längd
52-66	66		52-80	80
52-68	68		52-82	82
52-70	70		52-86	86
52-72	72		52-90	90
52-74	74		52-92	92
52-76	76		52-94	94
52-78	78			

Polaris kugghjul

Teräspyörät, 2-3 kertaa lujemmat kuin pulverimetallista tehdyt alkuperäiset

Ketjupyörä Silent ketjuille. Sopii kaikkiin Polaris kelkkoihin 1996-alkaen. (sopii myös Yamaha)						Hyvo ketjupyörät Polaris kelkoihin. Sopii kaikkiin 1998 alkaen, joissa on 3/4 Hyvo ketju					
11-breidd		13-breidd		15-breidd		3/4 Hyvo		3/4 Hyvo			
15 splines		15 splines		15 splines		15 splines		nedre kuggh			
1 "	Z	1 "	Z	1 "	Z	1 "	Z	15 s/1 "	Z		
49-344	17	51-359	17	53-433	17			52-751	17	52-770	35
49-346	18	51-360	18	53-432	18			52-752	18	52-772	36
49-348	19	51-362	19	53-434	19			52-754	19	52-774	37
49-350	20	51-364	20	53-436	20			52-756	20	52-776	38
49-352	21	51-366	21	53-438	21			52-758	21	52-778	39
49-354	22	51-368	22	53-440	22			52-760	22	52-780	40
49-356	23	51-370	23	53-442	23			52-762	23	52-782	41
49-358	24	51-372	24	53-444	24			52-764	24	52-784	42
49-357	25	51-371	25	53-446	25			52-766	25	52-786	43

Yamaha kugghjul

Teräspyörät, 2-3 kertaa lujemmat kuin pulverimetallista tehdyt alkuperäiset

Ketjupyörä Silent ketjuille. Sopii kaikkiin Yamaha kelkkoihin RX-1 saakka. (sopii myös Polaris)						Hyvo ketjupyörät Yamaha kelkoihin. Yläpyörässä on kaksi eri uritusta, ja 16 splines on niistä uusin versio					
11-breidd		13-breidd		15-breidd		3/4-Hyvo		3/4 Hyvo		3/4 Hyvo	
15 splines		15 splines		15 splines		16 splines		15 splines		nedre kuggh	
1 "	Z	1 "	Z	1 "	Z	27 mm	Z	1 "	Z	15 s/1 "	Z
49-344	17	51-359	17	53-433	17						
49-346	18	51-360	18	53-432	18	52-849	18	52-860	18		
49-348	19	51-362	19	53-434	19	52-850	19	52-861	19	52-871	35
49-350	20	51-364	20	53-436	20	52-851	20	52-862	20	52-869	36
49-352	21	51-366	21	53-438	21	52-852	21	52-863	21	52-872	37
49-354	22	51-368	22	53-440	22	52-853	22	52-864	22	52-873	38
49-356	23	51-370	23	53-442	23	52-854	23	52-865	23	52-874	39
49-358	24	51-372	24	53-444	24	52-855	24	52-866	24	52-875	40
49-357	25	51-371	25	53-446	25	52-856	25	52-867	25	52-876	41

CDI-Boxar



01-14342
Rotax 410.918.900



01-14343
Rotax 420.965.591



01-401
Arctic Cat 3004-099



01-14340
Rotax 420.866.595



01-415
Yamaha 8V0.85540.21



01-407
Polaris 3083725



01-14345
Rotax 420.965.757



01-40701
Polaris 3083989



01-40801
Polaris 3084007



01-14329
Arctic Cat 3003-777



01-14372
Skidoo 512.058.927 Form. Pol. 3083721 600-650

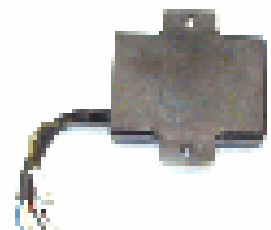

01-406



01-404
Polaris 308 3723



01-14327
Arctic Cat **69**



01-14332
Bosch, Skidoo, Motoski

Laddningspole

Tändspolar



01-14310
Rotax 410.916.000



01-14311
Rotax 410.913.500 Arctic



01-14319



01-14312
Arctic Cat 3003-221



01-14313
Polaris 3082974



01-143120
Arctic Cat 3003-977



01-14314
Yamaha 8W3.82310.10



01-14315
Yamaha 8E7.82310.10



01-14317
Yamaha 5.82310.40



01-14351
Yamaha 8AB.82310.10



01-14353
Arctic Cat 3003-575



01-14355
Rotax 10.920.500



01-14350
Yamaha Bravo 250 -88



01-14363
AC 3005-381 ZL-ZR 5-700



01-14371
Rotax 420.996.705
Form. III, Mach1, Z, ZR

Tändspolar



01-14360
Arctic Cat 3004-126



01-14361
Arctic Cat 3004-483



01-14362
Polaris 3084469



01-1430
Rotax, Bosch, Arctic Cat



01-14367
Polaris 3085293



01-14370
Formula 415.085.400

Nödstop



01-113 Arctic Cat



01-11120
Skidoo

01-11121
Skidoo 515.1515.00



01-11113
Yamaha, Arctic Cat, Polaris

Tändstift **BOSCH**



05-B8 BR8ES resistor skyddat
05-B9 BR9ES resistor skyddat



01-120
Universal, gamla
Tryck-stop-mod

Voltregulator

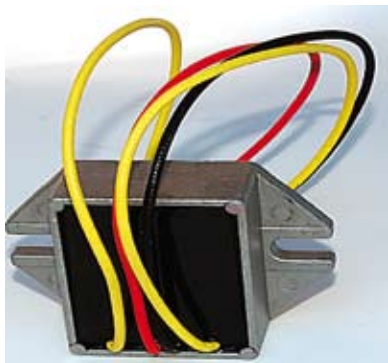

01-15416 3 tråd
01-15416B 4 tråd



01-15402
 Rotax 410.908.900



01-15406
 Rotax, Arctic Cat



01-15417 250 W
 Likriktare Rotax



01-15415
 Rotax 410.908.900



01-15421
 Polaris 4060122



01-15418
 Likriktare Arctic Cat



01-15426
 Arctic Cat 0232-014



01-15432
 Yamaha 82F.81910.

Kabelsko



01-110



01-1011



01-15435
 Yamaha 82M.81910.AO



01-15436
 Yamaha 98A.81910.00

Flippen

Bilder:

På bilderna ser du en montering av en 384 cm matta.

Montera axeln så mycket åt vänster i bilden som möjligt, se bild. Då får du en perfekt och tillräckligt justering.

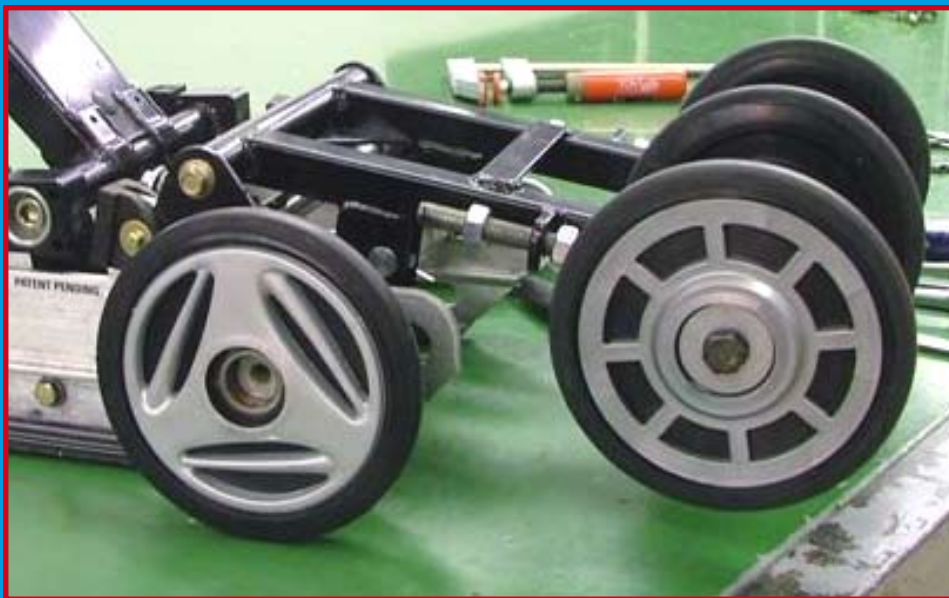

Bilder:

På bilderna ser du en montering av en 403 cm matta.

Montera axeln så mycket åt höger i bilden som möjligt, se bild. Då får du en perfekt och tillräckligt justering.

